



**PLEASE CHECK FOR CHANGE
INFORMATION AT THE REAR
OF THIS MANUAL.**

468
DIGITAL STORAGE
OSCILLOSCOPE
OPERATORS

Tektronix, Inc.
P.O. Box 500
Beaverton, Oregon 97077

070-2906-01
Product Group 40

INSTRUCTION MANUAL

Serial Number _____ First Printing MAY 1980
Revised APR 1984

Copyright © 1980, 1981 Tektronix, Inc. All rights reserved.
Contents of this publication may not be reproduced in any
form without the written permission of Tektronix, Inc.

Products of Tektronix, Inc. and its subsidiaries are covered
by U.S. and foreign patents and/or pending patents.

TEKTRONIX, TEK, SCOPE-MOBILE, and  are
registered trademarks of Tektronix, Inc. TELEQUIPMENT is
a registered trademark of Tektronix U.K. Limited.

Printed in U.S.A. Specification and price change privileges
are reserved.

INSTRUMENT SERIAL NUMBERS

Each instrument has a serial number on a panel insert, tag,
or stamped on the chassis. The first number or letter
designates the country of manufacture. The last five digits
of the serial number are assigned sequentially and are
unique to each instrument. Those manufactured in the
United states have six unique digits. The country of
manufacture is identified as follows:

B000000	Tektronix, Inc., Beaverton, Oregon, USA
100000	Tektronix Guernsey, Ltd., Channel Islands
200000	Tektronix United Kingdom, Ltd., London
300000	Sony/Tektronix, Japan
700000	Tektronix Holland, NV, Heerenveen, The Netherlands

TABLE OF CONTENTS

	Page		Page
LIST OF ILLUSTRATIONS	v	CONTROLS, CONNECTORS AND INDICATORS ...	9
LIST OF TABLES	vii	VERTICAL	9
SAFETY SUMMARY	viii	DISPLAY AND CALIBRATOR	14
		TRIGGERING	15
		HORIZONTAL AND POWER	19
		DIGITAL STORAGE	23
INTRODUCTION	1	REAR PANEL	33
NON STORE MODE	1	RIGHT SIDE PANEL	37
STORAGE MODE	1	LEFT SIDE PANEL	37
AVAILABLE OPTIONS	4		
		OPERATING CONSIDERATIONS	39
PREPARATION FOR USE	5	GRATICULE	39
LINE VOLTAGE SELECTION	5	GROUNDING	39
REGULATING RANGE SELECTION	6	SIGNAL CONNECTIONS	39
POWER CORD	7	INPUT COUPLING CAPACITOR	
POWER ON SELF-VERIFICATION	8	PRECHARGING	40
		INSTRUMENT COOLING	40

ACCESSORIES

STANDARD ACCESSORIES INCLUDED

Basic 468 Accessories

2 Probes, 10X, length 2 m, with accessories	010-6105-03
1 Accessory Pouch	016-0594-00
1 Accessory Pouch, Zipper	016-0537-00
1 Operators Manual	070-2906-01
1 Service Manual, Volume I	070-3515-00
1 Service Manual, Volume II	070-3516-00
2 Fuses, 1.5 A, 3AG slow-blow	159-0160-00
1 Fuse, 0.70 A, 3AG, slow-blow	159-0040-00
1 Crt Filter, Blue Plastic (installed)	337-1674-00
1 Crt Filter, Clear Plastic	337-1674-01
1 Adapter, Ground Wire	134-0016-01

Option 05 Accessories

2 Adapter, probe tip	103-0051-01
1 Graticule, NTSC	337-1674-02
1 Graticule, CCIR	337-1674-03

OPTIONAL ACCESSORIES

C-5C Option 02 low-cost general-purpose Camera—order
C-5C Option 02.

Protective Cover, waterproof, blue vinyl—order 016-0365-00.

Polarized Collapsible Viewing Hood—order 016-0180-00.

Folding Viewing Hood, light-shielding—order 016-0592-00.

Collapsible Viewing Hood, binocular—order 016-0566-00.

Mesh Filter—improves contrast and filters emi—order 378-0726-01.

SCOPE-MOBILE Cart—Occupies less than 18 inches of aisle space, with storage area in base—order 200C.

Crt Filter, smoke-gray—order 337-1674-07.

GPIB Option—GPIB I/F cable, single shielded:

2 meter length—order 012-0630-01.

4 meter length—order 012-0630-02.

Optional Power Cords

Standard, 3 meter length—order 161-0104-00.

Option A1, 3 meter length—order 161-0104-06.

Option A2, 3 meter length—order 161-0104-07.

Option A3, 3 meter length—order 161-0104-05.

Option A4, 3 meter length—order 161-0104-08.

TABLE OF CONTENTS (cont)

	Page		Page
OSCILLOSCOPE DISPLAYS	41	OPERATOR'S CHECKS AND ADJUSTMENTS (cont)	
NON STORE DISPLAYS	41	VERTICAL GAIN CHECK	55
NORMAL SWEEP DISPLAY	41	EXTERNAL HORIZONTAL GAIN CHECK.	56
MAGNIFIED SWEEP DISPLAY	43	VERTICAL DEFLECTION ACCURACY	
B DELAYED SWEEP DISPLAY	43	CHECK.	56
ALTERNATE HORIZONTAL SWEEP		VOLTS CURSOR ACCURACY CHECK	56
DISPLAY	44	TIME CURSOR ACCURACY CHECK.	57
X-Y DISPLAY	44	MAKING DIGITAL STORAGE MEASUREMENTS ..	59
SINGLE SWEEP DISPLAY	45	AC PEAK-TO-PEAK VOLTAGE	59
DIGITAL STORAGE DISPLAYS	46	INSTANTANEOUS DC VOLTAGE	61
NORM STORAGE MODE DISPLAY	46	TIME DURATION	63
ENVELOPE STORAGE MODE DISPLAY	48	FREQUENCY	64
AVG STORAGE MODE DISPLAY	49	RISE TIME	65
SAVE STORAGE MODE DISPLAY	50	WAVEFORM COMPARISON	67
SAVE REF DISPLAY	51	TIME DIFFERENCE BETWEEN	
OPERATOR'S CHECKS AND ADJUSTMENTS	52	REPETITIVE PULSES	68
TRACE ROTATION ADJUSTMENT	52	TIME DIFFERENCE BETWEEN TWO	
PROBE COMPENSATION	53	TIME-RELATED PULSES	69
ASTIGMATISM ADJUSTMENT	54		

Table 11 (cont)

Characteristics	Performance Requirements	Supplemental Information
SIGNAL AVERAGING OPTION 12		
Averaging Range	Two to 256 waveforms in a 2-4-8 binary sequence. Number of sweeps to be averaged set with CURSOR/NO. OF SWEEPS control knob when NO. OF SWEEPS push button (on side panel) is pressed in.	Uncorrelated noise, signal-to-noise ratio is improved by the square root of the number of waveforms averaged.

^a Performance requirement not checked in manual.

TABLE OF CONTENTS (cont)

	Page		Page
MAKING DIGITAL STORAGE MEASUREMENTS (cont)		MAKING NONSTORAGE MEASUREMENTS (cont)	
PHASE DIFFERENCE BETWEEN SINUSOIDAL SIGNALS	71	TIME DURATION	91
SLOPE	73	FREQUENCY	92
LOW-LEVEL SIGNAL MEASUREMENTS . . .	74	RISE TIME	92
EXPANSION OF NORM STORAGE		TIME DIFFERENCE BETWEEN TWO	
DISPLAYS	75	TIME-RELATED PULSES	93
ENVELOPE STORAGE MODE	77	TIME COMPARISON	95
Anti-Aliasing	77	PHASE DIFFERENCE	96
Glitch Catching	79	HIGH-RESOLUTION PHASE DIFFERENCE . .	98
Glitch Measurement	80	DELAYED SWEEP MAGNIFICATION	98
Missing Pulse	82	Magnified Sweep Starts After Delay	99
		Triggered Delayed Sweep Magnification . .	101
MAKING NONSTORAGE MEASUREMENTS	84	DELAYED SWEEP TIME MEASUREMENTS .	102
AC PEAK-TO-PEAK VOLTAGE	84	Time Duration	102
INSTANTANEOUS DC VOLTAGE	86	Frequency	103
ALGEBRAIC ADDITION	87	Rise Time	104
COMMON-MODE REJECTION	89	Time Difference Between Repetitive Pulses	105
AMPLITUDE COMPARISON	90	Time Difference Between Two	
		Time-Related Pulses	107

Table 11 (cont)

Characteristics	Performance Requirements	Supplemental Information
ANALOG X-Y OUTPUT OPTION 11		
X and Y Output Sensitivity	200 mV/div	Within $\pm 3\%$, measured with respect to on-screen cursors.
Range	0 to 2.048 V.	0 to 10.24 div.
Resolution Y-Axis		8 bit.
X-Axis		8 or 9 bit.
PEN LIFT		Relay contact closure to ground, polarity switchable. Maximum relay current is 200 mA, fused at 250 mA. Maximum applied voltage is 30 V peak. A 10-kilohm pull-up resistor to the +5-V supply is switchable to provide TTL pen-lift levels.
PLOT SPEED		Switch selectable between fast and slow
Switch Open	Fast plot.	40 ms $\pm 10\%$ per data point.
Switch Closed	Slow plot	320 ms $\pm 10\%$ per data point.

TABLE OF CONTENTS (cont)

	Page		Page
OPTIONS	109	OPTIONS (cont)	
GENERAL DESCRIPTION	109	Vertical Calibration for CCIR and NTSC Video	
OPTION 02 OPERATING INFORMATION	109	Graticules	143
A Typical System on the GPIB	110	Operation of the Sync Separator	144
Controllers, Talkers, and Listeners	111	Vertical Operating Modes—Special	
GPIB Signal Line Definitions	111	Considerations	145
GPIB Connector	115	Typical Operation	146
Interface Functions and Commands	115	Selecting an Individual Line	147
GPIB Switch Operation	119	Special Measurements	148
Power-Up State	122	Identifying Fields, Frames, and Lines in 525/60	
Power-Down State	122	and 625/50 TV Systems	149
GPIB Status Indicator	123	OPTION 11 OPERATING INFORMATION	151
GPIB Status Bytes	123	Introduction	151
468 GPIB Message Protocol	124	Setting Up the Option	151
468 Message	125	Using the Option	152
Calculating Coordinate Values	129		
Driver Program	133	SPECIFICATION	155
OPTION 05 TV SYNC SEPARATOR	140		
General Information	140	ACCESSORIES	192
Specification	142	STANDARD ACCESSORIES INCLUDED	192
Furnished Accessories	143	OPTIONAL ACCESSORIES	192
Installation of the Video Graticule	143		
		CHANGE PAGE	

Table 11
OPTION ELECTRICAL CHARACTERISTICS

Characteristics	Performance Requirement	Supplemental Information
GENERAL PURPOSE INTERFACE BUS (GPIB) OPTION 02		
Interface Function ^a	SH1 Source Handshake. AH1 Acceptor Handshake. T1 Basic talker, talk only mode, serial poll. LO No Listener. SR1 Service Request. RL0 No Remote/Local. PP0 No Parallel Poll. DC2 Device Clear. DT0 No Device Trigger. C0 No Controller.	
Waveform Data Transmitted	Conforms to Tektronix Interface Standard, GPIB Codes and Formats (Rev. C). ^a	When no waveform has been acquired, only the ID portion of the waveform message will be transmitted.

LIST OF ILLUSTRATIONS

Figure	Page	Figure	Page
	x	13	53
1	6	14	55
2	7	15	57
3	10	16	58
4	14	17	60
5	16	18	63
6	20	19	64
7	22	20	65
8	24	21	66
9	31	22	68
10	34	23	69
11	36	24	70
12	38	25	72
		26	74
		27	75
		28	76
		29	78
		30	80

**Table 10
PHYSICAL CHARACTERISTICS**

Characteristics	Description
Weight	
With Panel cover, Accessories, and Accessory Pouch	33 pounds (15 kg).
Without Panel Cover, Accessories, and Accessory Pouch	30 pounds (13.6 kg).
Domestic Shipping Weight	47 pounds (21.7 kg).
Height	
With Feet and Pouch	7.5 inches (19.1 cm).
Without Pouch	7.2 inches (18.3 cm).
Width	
With Handle	12.9 inches (32.8 cm).
Without Handle	11.5 inches (29.2 cm).
Depth	
Including Panel Cover	21.7 inches (55 cm).
Handle Extended	23.7 inches (60 cm).

LIST OF ILLUSTRATIONS (cont)

Figure	Page	Figure	Page
31	Glitch display, NORM Storage Mode using B DLY'D HORIZ DISPLAY	45	Rise time, differential time method
	81	46	Time difference between repetitive pulses
32	Missing pulse, ENVELOPE Storage Mode	47	Time difference between two time-related pulses, ALT HORIZ DISPLAY
33	Peak-to-peak waveform measurement		108
34	Instantaneous voltage measurement	48	A typical system using the general purpose interface bus (GPIB)
35	Algebraic addition		112
36	Common-mode rejection	49	A typical handshake timing sequence (idealized).
37	Time duration		113
38	Rise time	50	GPIB connector and pin assignments
39	Time difference between two time-related pulses	51	GPIB switch register
	94	52	The 468 Oscilloscope with Option 05
40	Phase difference	53	Location of Analog X-Y Output Option switches and output connectors
41	High-resolution phase difference		153
42	Delayed sweep magnification	54	Location of Analog X-Y Output PLOT switch
43	Time duration using delayed sweep		154
44	DELAY TIME POSITION control settings for time duration measurement example		
	103		

Table 9
ENVIRONMENTAL CHARACTERISTICS

Characteristics	Description
	<p><i>NOTE</i></p> <p><i>All of the environmental tests performed meet the requirement of MIL-T-28800B, Class 3, Style D equipment.</i></p>
Temperature	
Nonoperating (Storage)	-62°C to +85°C.
Operating	-15°C to +55°C.
Altitude	
Nonoperating (Storage)	To 50,000 ft.
Operating	To 15,000 ft.
Humidity (Operating and nonoperating)	5 cycles (120 hrs) referenced to MIL-T-28800B, Par. 3.9.2.2. Class 3, 95% to 97% relative humidity.
Vibration (Operating)	15 minutes along each of 3 major axes at a total displacement of 0.025 inch p-p (4 g's at 55 Hz), with frequency varied from 10 Hz to 55 Hz to 10 Hz in 1-minute sweeps. Hold 10 minutes at each major resonance, or if no major resonance present, hold 10 minutes at 55 Hz.
Shock (Operating and Nonoperating)	30 g's, half-sine, 11 ms duration, 3 shocks per axis in each direction for a total of 18 shocks.
EMI	
Option 04 Only	Meets TEKTRONIX Standard 062-2866-00 with exception of RE02 relaxed 20 dB.

LIST OF TABLES

Table		Page
1	Fuse Selection	5
2	Regulating Ranges	6
3	Priority Storage Plan	47
4	468 GPIB Function Subsets	117
5	Interface Commands	118
6	468 Status Bytes	124
7	BNF Symbol Notation	126
8	Electrical Characteristics	155
9	Environmental Characteristics	187
10	Physical Characteristics	188
11	Option Electrical Characteristics	189

Table 8 (cont)
INTERNAL POWER SUPPLIES

Characteristics	Supplemental Information				
	Initial Setting	Any 500-Hour Period After First 200 Hours	Maximum p-p Ripple	Accuracy From -15°C to 55°C	
Main Supply Accuracy ($+20^{\circ}\text{C}$ to $+30^{\circ}\text{C}$)	-8 V	$\pm 0.9\%$	$\pm 1.7\%$	2 mV	Within 0.5% of 25°C value
	$+5\text{ V}$	$\pm 0.9\%$	$\pm 1.7\%$	2 mV	Within 0.5% of 25°C value
	$+15\text{ V}$	$\pm 0.9\%$	$\pm 1.7\%$	2 mV	Within 0.5% of 25°C value
	$+55\text{ V}$	$\pm 0.3\%$	$\pm 0.7\%$	4 mV	Within 0.5% of 25°C value
	-2450 V	$\pm 1.2\%$	$\pm 2.2\%$		
	$+110\text{ V}$	$\pm 3\%$		100 mV	
Digital Storage Power Supplies (Not Adjustable)	Voltage	-6 V	-12 V	$+5\text{ V}$	$+12\text{ v}$
	Tolerance	$\pm 4\%$	$\pm 5\%$	$\pm 4\%$	$\pm 5\%$
	Maximum p-p Ripple			150 mV	

^a Performance requirement not checked in manual.

OPERATORS SAFETY SUMMARY

The general safety information in this summary is for operating personnel. Specific warnings and cautions will be found throughout the manual where they apply and do not appear in this summary.

TERMS

In This Manual

CAUTION statements identify conditions or practices that could result in damage to the equipment or other property.

WARNING statements identify conditions or practices that could result in personal injury or loss of life.

As Marked on Equipment

CAUTION indicates either a personal injury hazard not immediately accessible as you read the marking, or a hazard to property including the instrument itself.

DANGER indicates a personal injury hazard immediately accessible as one reads the marking.

SYMBOLS

As Marked on Equipment



DANGER — High voltage.



Protective ground (earth) terminal.



ATTENTION — refer to manual.

PRECAUTIONS

Power Source

This product is intended to operate from a power source that will not apply more than 250 volts rms between the supply conductors or between either supply conductor and

Table 8 (cont)

Characteristics	Performance Requirements	Supplemental Information
POWER SOURCE		
AC-Source Voltage Ranges		
115 V		
(High)	108 V to 132 V. ^a	
(Low)	90 V to 110 V. ^a	
230 V		
(High)	216 V to 250 V. ^a	
(Low)	198 V to 242 V. ^a	
AC-Source Frequency	48 Hz to 440 Hz. ^a	
Power Consumption		
Typical	115 watts (140 VA). ^a	
Maximum	150 watts (190 VA). ^a	48 Hz, 110 Vac, low regulating range.

ground. A protective ground connection by way of the grounding conductor in the power cord is essential for safe operation.

Grounding the Product

This product is grounded through the grounding conductor of the power cord. To avoid electrical shock, plug the power cord into a properly wired receptacle before connecting to the product input or output terminals. A protective ground connection by way of the grounding conductor in the power module power cord is essential for safe operation.

Use the Proper Power Cord

Use only the power cord and connector specified for your instrument and locale.

Use only a power cord that is in good condition.

Use the Proper Fuse

To avoid fire hazard, use only the fuse specified for your instrument. Replacement fuses should be identical in type, voltage rating, and current rating. Line fuses must match the selected source of ac power and must be changed when nominal voltage range is changed.

Do Not Operate in Explosive Atmospheres

To avoid explosion, do not operate this product in an atmosphere of explosive gases unless it has been specifically certified for such operation.

Do Not Remove Covers or Panels

To avoid personal injury, do not remove covers or panels from this product. Do not operate the product without properly installed covers and panels.

Table 8 (cont)

Characteristics	Performance Requirements	Supplemental Information
SIGNAL OUTPUTS		
CH 1 VERT SIGNAL OUT		
Output Voltage	At least 50 mV per division of displayed signal into 1 M Ω . At least 25 mV per division of displayed signal into 50 Ω .	
Output Resistance		Approximately 50 Ω .
Bandwidth	Dc to at least 50 MHz into 50 Ω .	
DC Level	Approximately 0 V.	Within 100 mV.
A and B + GATES		
Output Voltage	Approximately 5.5 V, positive-going rectangular pulse.	Starts at 0 V, within 500 mV.
Output Resistance		Approximately 500 Ω .

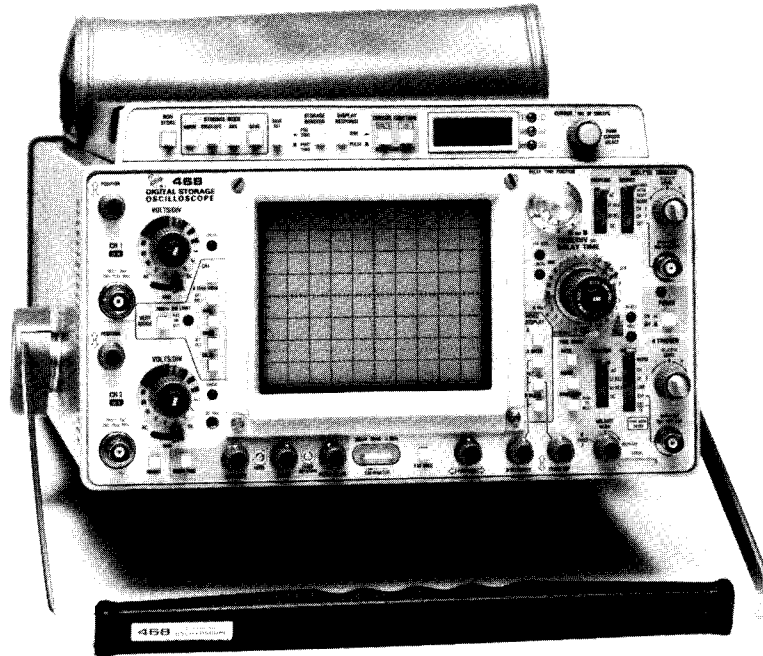

2906-01

The 468 Digital Storage Oscilloscope.

Table 8 (cont)

Characteristics	Performance Requirements	Supplemental Information
Z-AXIS INPUT		
Sensitivity	5 V p-p signal causes noticeable modulation at normal intensity.	Positive-going signal decreases intensity.
Usable Frequency Range	Dc to 50 MHz. ^a	
Input Resistance		25 k Ω , within 10%. Decreases to approximately 200 Ω at 2 MHz and above.
Maximum Input Voltage		25 V (dc + peak ac).

INTRODUCTION

The TEKTRONIX 468 Oscilloscope is a portable digital storage oscilloscope with a four-trace, dc-to-100 MHz, vertical deflection system. The 468 combines an easy-to-use storage function with cursor measurement of time and voltage. Measurement values are indicated on a four-digit, seven-segment LED display.

NON STORE MODE

In the NON STORE mode, the 468 operates as a conventional oscilloscope that can display CH 1, CH 2, ADD, and A TRIG VIEW (external trigger only) simultaneously. The vertical deflection system has calibrated deflection factors ranging from 5 mV to 5 V per division. The horizontal deflection system has calibrated A Sweep rates from 0.5 s to 0.02 μ s per division and is capable of operating in the following sweep modes: A,A intensified by B,A alternated with delayed B, and B delayed. The calibrated B Sweep rates are from 50 ms to 0.02 μ s per division.

The horizontal magnifier circuit feature increases each sweep rate by a factor of 10. This provides a maximum sweep rate of 2 ns per division when the TIME/DIV switch is in the 0.02 μ s per division position.

STORAGE MODE

The 468 digital storage circuitry has a 10 MHz Useful Storage Bandwidth for the acquisition of signals, and will display the acquired waveform with a bright, flicker-free trace. With the digital storage feature, low-frequency signal analysis and waveform measurements—previously difficult or impossible to make—are easily performed. A choice of two standard and one optional signal acquisition modes are available: NORM and ENVELOPE (standard) and AVG (optional). Two storage functions are available to hold a display indefinitely for measurement and comparison: SAVE Storage Mode (stops acquisition) and SAVE REF (holds a reference display and continues acquisition in the selected Storage Mode). Waveform data may be acquired prior to or after the trigger using the PRE TRIG or POST TRIG Storage Window. Time and voltage measurements on the acquired waveform are easily made using the VOLTS and

Table 8 (cont)

Characteristics	Performance Requirements	Supplemental Information
CALIBRATOR		
Output voltage 0°C to +40°C	0.3 V, within 1.0%	Within 0.5% at 25°C, ±5°C.
–15°C to +55°C		0.3 V, within 1.5%.
Repetition Rate	Approximately 1 kHz.	Within 25%.
Output Resistance		Approximately 10.3 Ω.
Output Current +20°C to +30°C	30 mA, within 2%. ^a	
–15°C to +55°C		30 mA, within 2.5%.

TIME Cursor Functions, and the measurement values are indicated on a four-digit, seven-segment light-emitting diode (LED) display.

Digital storage adds three TIME/DIV switch positions, increasing the storage time base to 5 s per division (a total sweep time of 50 s). The waveshape of signals acquired at these low frequencies would be impossible to view on a conventional oscilloscope. Digital storage circuitry, however, constantly refreshes an acquired waveform to produce a directly viewable display for ease of analysis and measurement. Three added VOLTS/DIV switch positions increase the digital storage vertical deflection sensitivity up to 0.5 mV per division. Small-amplitude signals are acquired at 5 mV per division and are amplified to produce the added sensitivity.

The digital storage signal acquisition modes are NORM and ENVELOPE Storage Modes, and an optional AVG Storage Mode. Selecting NORM Storage Mode causes acquisition and display of a new waveform with each trigger. The display in this mode most resembles conventional oscilloscope displays, and waveforms acquired will react to the oscilloscope front-panel controls with each trigger.

When ENVELOPE Storage Mode is chosen, the maximum and minimum waveform values for a selected number of sweeps are acquired, and the resultant waveform envelope is displayed. This mode is useful for detecting noise and spurious or erratic signals.

Choosing the optional AVG Storage Mode allows waveforms to be acquired for a selected number of sweeps and causes the averaged value of the acquired signals to be displayed. In this mode, signal-to-noise ratio is improved in direct proportion to the square root of the number of sweeps acquired, and noise accompanying the signal is either averaged out or reduced to a small level. The signal acquired in the AVG Storage Mode is processed to increase the vertical resolution of the displayed signal. This feature is very useful for displaying small-amplitude signals acquired in the 0.5, 1, and 2 mV per division positions of the VOLTS/DIV switch.

Once the desired signal is obtained in storage, the signal acquisition may be halted and the display frozen by selecting the SAVE Storage Mode. The waveform will remain displayed indefinitely for analysis and measurement purposes. In the SAVE mode, the next six faster positions of the TIME/DIV switch (if available) horizontally expand the display (up to 100 times). Additionally, signals acquired at sweep rates of 1 μ s per division or faster, may be reduced back to the 2 μ s per division acquisition rate.

Table 8 (cont)

Characteristics	Performance Requirements	Supplemental Information
CRT DISPLAY (cont)		
Standard Phosphor		P31 (green).
Nominal Accelerating Potential		18.5 kV.
Electrode Voltages to Ground Heater Voltage Between CRT Pins 1 and 14		6.3 Vrms, ± 3 V; elevated to -2450 V.
Cathode (Pin 2)		-2450 V, $\pm 2\%$.
Grid No. 1 (Pin 3)		≈ -2455 V to -2555 V.
Focus (Pin 4)		≈ -1780 V to -2000 V.
Astigmatism (Pin 5)		0 V to $\approx +95$ V.
Isolation Shield (Pin 7)		$+35$ V, ± 5 V.
First Anode (Pin 8)		$\approx +55$ V.
Geometry (Pin 10)		0 to $\approx +95$ V.
Mesh (Pin 12)		≈ -150 V.

The SAVE display may also be expanded vertically (up to 10 times) with the next three higher deflection sensitivity positions of the VOLTS/DIV switch (if available) for the channel used to obtain the SAVE display. Signals obtained in the NORM or ENVELOPE Storage Mode at VOLTS/DIV switch settings of 0.5, 1 or 2 mV per division may be reduced back to the 5 mV per division deflection sensitivity if desired. The SAVE display of a waveform acquired in the AVG Storage Mode may be expanded, but it may not be reduced below the deflection sensitivity at which the signal was acquired.

When the SAVE REF push button is pressed in, the waveform being displayed at that time will be stored and held on the display while the digital storage continues to acquire data. The SAVE REF display is then available for comparison with signals obtained from other circuits, or it can be used as a before-and-after check on circuit operation when changes or adjustments are made to the circuit under test. A new reference waveform is obtained each time the button is released and then pressed in again. Displaying the reference signal reduces the number of vertical mode possibilities that the 468 is capable of displaying simultaneously.

The time window used to obtain a stored waveform may be set to acquire either approximately 8.75 horizontal divisions of waveform data occurring before the triggering sig-

nal (in PRE TRIG Storage Window) or the same amount of waveform data occurring after the triggering signal (in POST TRIG Storage Window). The PRE TRIG feature is useful for analyzing events that might cause an error to occur. If the oscilloscope is set to trigger on the error, data immediately prior to the error is stored for analysis. POST TRIG Storage Window most resembles conventional triggering; but while conventional oscilloscope triggering usually starts the sweep, POST TRIG Storage Window triggering does not occur until approximately 1.25 horizontal divisions of waveform data are acquired.

Voltage and time measurements are made directly on the displayed waveform. Pressing in the VOLTS Cursor Function push button causes two horizontal lines (VOLTS Cursors) to be presented on the display. Only one cursor at a time is positionable using the CURSOR control knob. The active cursor is displayed as a dashed line, while the fixed cursor is a solid line. Voltage difference (as represented by the cursor positions) is directly read on the seven-segment LED display, and the appropriate measurement scale factor is shown on the three dual-color (red and green) LED indicators to the right of the seven-segment LED display. Time measurements are made using two bright, positionable dots that appear on the trace when the TIME Cursor Function button is pressed in. The TIME cursor dots are positioned to the desired measurement points, and the time difference between the dots is directly read on the LED display.

Table 8 (cont)

Characteristics	Performance Requirements	Supplemental Information
STORAGE DISPLAY (cont)		
TIME Readout (cont) Resolution		1 part in 1024 (10 bit). <p style="text-align: center;"><i>NOTE</i></p> <p style="text-align: center;"><i>Scale-factor LED indicates measurement is in DIV in the VOLTS measurement mode when vertical UNCAL LED is illuminated, or are used in a dual-channel mode.</i></p>
CRT DISPLAY		
Display Area		8 X 10 cm.
Geometry		0.1 division or less of tilt or bowing.
Trace Rotation Range		Adequate to align trace with horizontal graticule lines. At least $\pm 3^\circ$.

A COUPLED V/T measurement mode is made available by pressing in both the VOLTS and TIME Cursor Function push buttons. In this mode, the TIME dots attach to the VOLTS cursors, and the VOLTS cursors will never be displayed beyond the limits of the waveform. The COUPLED V/T mode is useful for slope, peak-to-peak amplitude, and time duration measurements. While the cursors are coupled, the LED readout will display the voltage difference between the cursors. In instruments factory equipped or converted to firmware version 2.0 or higher, the COUPLED V/T mode is also useful for making absolute dc-voltage measurements with respect to ground.

AVAILABLE OPTIONS

Option 02 is the General Purpose Interface Bus (GPIB), used to transmit the waveform data stored in the display memory. The waveform data transmitted will conform to the Waveform Transmission Standard as specified in the Tektronix Interface Standard—General Purpose Interface Bus (GPIB), Codes and Formats.

NOTE

The 468 Oscilloscope cannot be equipped with both Option 02 and Option 11 due to use of common space.

Option 04 (EMC) provides additional reduction of electromagnetic interference.

Option 05 provides the instrument with front-panel selection of additional trigger-signal processing capabilities to facilitate observation and measurement of composite video and related television waveforms.

Option 11 enables the 468 to convert the digital data stored in memory into analog X and Y outputs for driving an X-Y Plotter.

Option 12 is the AVE Storage Mode. This option will acquire data for a selected number of sweeps (from 2 to 256 in a binary sequence) and display the average waveform accumulated.

NOTE

The AVE Storage Mode is part of the standard instrument above SN B032430.

Table 8 (cont)

Characteristics	Performance Requirements	Supplemental Information
STORAGE DISPLAY (cont)		
Display Type		Four-digit, seven-segment LED indicators.
VOLTS Readout		Displays calculated voltage difference between horizontal cursors in VOLTS measurement mode. Scale factor is determined by VOLTS/DIV switch setting.
Resolution		1 part in 1024 (10 bit).
TIME Readout		Displays calculated time difference between cursor dots in TIME measurement mode. Scale factor determined by setting of the appropriate TIME/DIV switch (A or B).

PREPARATION FOR USE

Refer to the Safety Summary at the front of this manual for power source, grounding, and other safety considerations pertaining to the use of this instrument. Before applying power, verify that the Line Voltage Selector switch and the Regulating Range Selector switch are both set for the ac-power input voltage source available and that the proper line fuse is installed.

CAUTION

This instrument may be damaged if operation with either the Line Voltage Selector switch or the Regulating Range Selector switch set for the wrong applied ac-power input source voltage or if the wrong line fuse is installed.

nominal voltage (see Figure 1). The detachable power cord may have to be changed to match the ac-power-source outlet. (See the "Power Cord" discussion in this manual for optional power cords.) Verify that the proper line fuse is installed (see Table 1).

LINE VOLTAGE SELECTION

This instrument operates from either a 115 V or a 230 V nominal ac-power source with a line frequency from 48 Hz to 440 Hz. To convert the instrument for operation from one ac source to the other, disconnect the power cord from the power input source, and move the Line Voltage Selector (230/115) switch to the position indicating the available

Table 1
FUSE SELECTION

Line Voltage Selector Switch Position	Fuse Size
115 V Nominal	1.5 A, 3AG, Slow-blow
230 V Nominal	0.7 A, 3AG, Slow-blow

Table 8 (cont)

Characteristics	Performance Requirements	Supplemental Information
STORAGE DISPLAY (cont)		
Jitter Correction		Reduces effect of sample clock-to-trigger jitter.
Gain		0.4 division, $\pm 10\%$; X10 MAG on.
Resolution		<p>± 0.1 sample period for TIME/DIV switch settings of 20 μs to 5 s per division. ± 3 ns for switch settings of 0.02 μs to 10 μs per division.</p> <p style="text-align: center;"><i>NOTE</i></p> <p><i>Due to inherent uncertainty involved in the jitter correction, the resolution will occasionally, at random intervals, exceed the limits given above.</i></p>

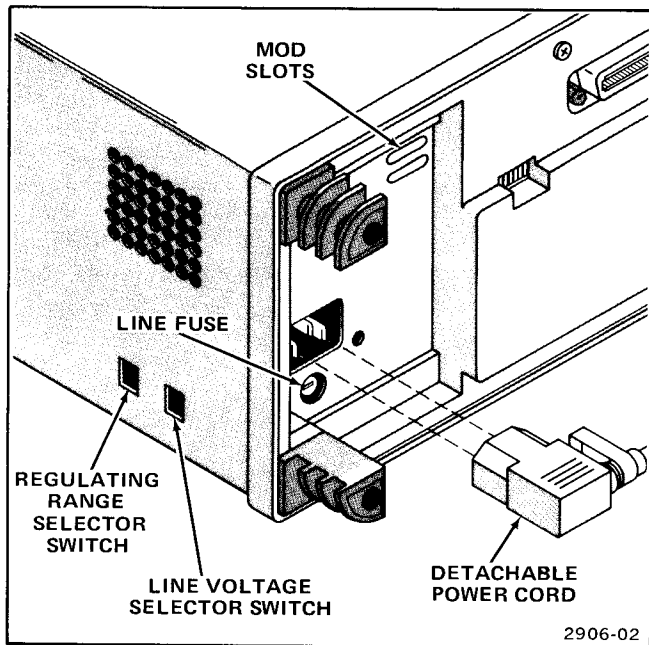

Figure 1. Ac-power-source switches, line fuse, and power cord.

REGULATING RANGE SELECTION

The Regulating Range Selector (HIGH/LOW) switch is located on the right side panel near the Line Voltage Selector switch (Figure 1.) Verify that the selector switch is set for the average line voltage being used. See Table 2 for a listing of the regulating ranges.

To change the regulating range:

1. Disconnect the instrument from the ac-power source.
2. Select a range from Table 2 that corresponds to the average ac-power source voltage available and set the selector switch to the required position.

Table 2
REGULATING RANGES

Regulating Range Selector Switch Position	Regulating Range	
	115 V Nominal	230 V Nominal
HIGH	108 V to 132 V	216 V to 250 V
LOW	90 V to 110 V	198 V to 242 V

Table 8 (cont)

Characteristics	Performance Requirements	Supplemental Information
STORAGE DISPLAY (cont)		
Display Response (cont) PULSE		<p>Microprocessor performs linear interpolation between data points to optimize the display response for fast-rise and fast-fall waveforms (rise and fall times faster than 3 times the sampling interval).</p> <p>For a 6-division sinusoidal input at seven samples per input cycle period, PULSE Display Response envelope distortion produces a maximum amplitude error at any peak which is less than 5% of the ideally reconstructed reference p-p amplitude.</p>

POWER CORD

This instrument has a detachable, three-wire power cord with a three-contact plug for connection to the power source and to protective ground. The plug protective ground contact connects (through the power cord protective grounding conductor) to the accessible metal parts of the equipment. For electrical-shock protection, insert this plug into a power source outlet that has a securely grounded protective-ground contact.

For the non-U.S. customer, the appropriate power cord used is supplied by an option specified when the instrument is ordered. The optional power cords available are illustrated in Figure 2. For part numbers and further information about accessories, refer to the accessories information page at the back of this manual, or contact your Tektronix representative or local Tektronix Field Office.





Plug Configuration	Usage	Nominal Line-Voltage (AC)	Reference Standards	Option #
	North American 120V/ 15A	120V	ANSI C73.11 ^a NEMA 5-15-P ^b IEC 83 ^c	Standard
	Universal Euro 240V/ 10-16A	240V	CEE (7), II, IV, VII ^d IEC 83 ^c	A1
	UK 240V/ 13A	240V	BS 1363 ^e IEC 83 ^c	A2
	Australian 240V/ 10A	240V	AS C112 ^f	A3
	North American 240V/ 15A	240V	ANSI C73.20 ^a NEMA 6-15-P ^b IEC 83 ^c	A4
^a ANSI—American National Standards Institute ^b NEMA—National Electrical Manufacturer's Association ^c IEC—International Electrotechnical Commission ^d CEE—International Commission on Rules for the Approval of Electrical Equipment ^e BS—British Standards Institution ^f AS—Standards Association of Australia				2931-05

Figure 2. Optional power cords for the 468.

Table 8 (cont)

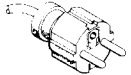
Characteristics	Performance Requirements	Supplemental Information
STORAGE DISPLAY (cont)		
Horizontal (cont) Position Registration		Sweep start between NON STORE and Storage within ± 0.2 division at TIME/DIV switch setting of 1 ms.
Display Response (Selectable) SINE		<p>Microprocessor performs an interpolation between data points that is optimized to produce the best response for input signals that have no frequency components above $F_s/2$, when F_s is the sampling rate.</p> <p>For a 6-division, sinusoidal input digitized at 2.5 samples per input cycle and expanded 10X with the TIME/DIV switch, SINE Display Response envelope distortion produces a maximum amplitude error at any peak which is less than 5% of the ideally reconstructed reference p-p amplitude, assuming no distortion in the acquired input signal.</p>

POWER ON SELF-VERIFICATION

A limited self-test is performed by the digital storage circuitry whenever power is applied to this instrument. If all the self-tests are passed, the oscilloscope will operate. If the system, random-access memory (RAM) or read-only memory (ROM) fails the test, the instrument halts and will not operate.

As an aid to servicing, a failure code is displayed in the seven-segment, light-emitting diode (LED) indicators to help a service technician locate the area of failure. This error code will remain displayed in either the storage or nonstorage mode, and power may be applied with either mode selected.

NOTE

If power is applied while a storage mode is selected and while one of the measurement cursors (VOLTS or TIME) is also selected, a normal display may appear in the LED indicators (after the self-test is completed). To avoid possibly confusing a normal display with an error display, either release the cursor push buttons or select the NON STORE mode before applying power to the instrument.

Should an error indication appear in the display, ensure that the NON STORE push button is pressed, then restart the self test by cycling the POWER switch off, then on again. If the error display appears a second time, refer the instrument to qualified service personnel.

Table 8 (cont)

Characteristics	Performance Requirements	Supplemental Information
STORAGE DISPLAY (cont)		
Vertical (cont) Rise Time		<p>≤0.3 horizontal graticule division for a five-division step, with horizontal X10 MAG on.</p> <p>Checked with no samples on the rising edge of the waveform.</p>
Aberrations		+6%, -6%, 6% p-p or less on a five-division step (fast rise) input.
Horizontal Resolution		1 part in 1024 (10 bit). Calibrated for 100 points per division.
Differential Accuracy	Graticule indication of time cursor difference is within 2% of LED readout value, measured over center eight divisions.	
SAVE Mode Gain Range (Horizontal)		Up to X100 as determined by the setting of the TIME/DIV switch.

CONTROLS, CONNECTORS AND INDICATORS

VERTICAL

Refer to Figure 3 for location of items 1 through 11.

- ① **VOLTS/DIV Switches**—Select the vertical deflections factor from 5 mV per division to 5 V per division in 10 steps for Channel 1 and Channel 2 in a 1-2-5 sequence. Three additional switch positions (0.5 mV, 1 mV, and 2 mV) are used in storage modes to vertically expand the waveform acquired at 5 mV per division (up to 10 times). VAR control must be in the calibrated detent to obtain a calibrated deflection factor. These switches also set the scale factor of the digital storage VOLTS measurement LED readout.

When a stored waveform is displayed in the SAVE Storage mode, the VOLTS/DIV switch vertically expands the appropriate channel display up to 10 times in a 1-2-5 sequence. Waveforms acquired in NORM and ENVELOPE Storage modes at VOLTS/DIV settings of 2, 1, or 0.5 mV per division, may be reduced back to 5 mV per division deflection if desired.

NOTE

In firmware version 1.0, SAVE Storage Mode waveforms acquired at VOLTS/DIV attenuator settings of 5 mV per division, and higher, cannot be reduced below the deflection sensitivity at which they were acquired. An attempt to do so will cause an invalid VOLTS readout on the LED indicators. Additionally, an attempt to expand the display vertically beyond a factor of ten will also result in an invalid VOLTS readout on the LED indicators.

In instruments factory equipped or converted to firmware version 2.0 or higher, attempting to reduce the display below the limits at which it was acquired will cause the display to cease reducing and the VOLTS readout to change to DIV scale factor. Attempting to expand the display beyond instrument limits causes the display and the VOLTS readout scale factor to cease changing.

- ② **VOLTS/DIV Readout**—Consist of two light-emitting diodes (LED) for each channel, located beneath the

Table 8 (cont)

Characteristics	Performance Requirements	Supplemental Information
STORAGE DISPLAY (cont)		
Vertical (cont) POSITION Range		Any portion of a stored waveform vertically magnified X10 can be positioned to the top and to the bottom of the graticule area.
Position Registration NON STORE to NORM		Within ± 0.5 division at graticule center at VOLTS/DIV settings from 5 mV to 5 V per division.
NORM, ENVELOPE, or AVG to SAVE		Within ± 0.2 divisions at VOLTS/DIV settings from 5 mV to 5 V per division.
SAVE Mode Gain Range (Vertical)		Up to X10 as determined by the setting of the VOLTS/DIV switch.
ENVELOPE Fill		90% or more of a six division ENVELOPE display.

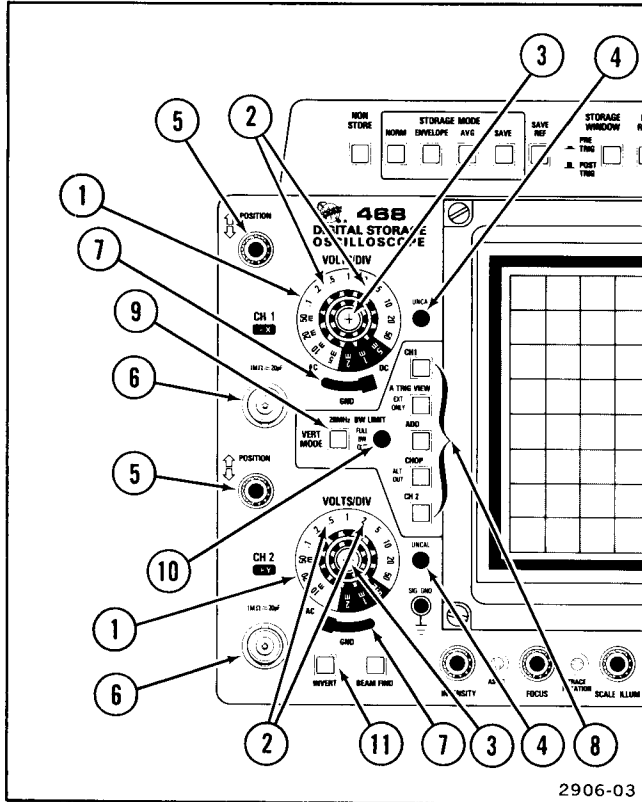

Figure 3. Vertical controls, connectors, and indicators.

skirt of each VOLTS/DIV knob. Either one LED or the other will light to indicate the correct deflection factor (if the channel is active). The 10X LED is illuminated only when a 10X probe with a scale-factor-coding-ring contact is connected to the input of the oscilloscope; otherwise, the 1X LED is illuminated. In the 0.5-, 1-, and 2-mV positions of the VOLTS/DIV switch, the LED will not be illuminated for the NON STORE mode.

- 3 **VAR Control**—Provides variable uncalibrated deflection factors between the calibrated settings of the VOLTS/DIV switches when storage is off. In a storage mode, if the VAR control is out of the calibrated detent, digital storage circuitry will continue to acquire data; but the storage scale-factor LED will indicate that VOLTS function measurements are in divisions (DIV).

NOTE

For instruments with Option 02 (GPIB), a firmware bug exists in both version 1.0 and version 2.0 ROM. This causes an incorrect transmission of the Y-multiplier and the Y-units of a waveform whenever the acquired waveform is vertically uncalibrated or when an ADD display is obtained with unequal VOLTS/DIV switch settings. To avoid this bug rotate the VAR VOLTS/DIV controls into the detent position and use the same VOLTS/DIV switch setting on both channels for ADD displays when acquiring the data for transmission.

Table 8 (cont)

Characteristics	Performance Requirements	Supplemental Information
DIGITAL STORAGE HORIZONTAL ACQUISITION (cont)		
Accuracy (Sample Period)		Sample clock is within 0.01% of selected sample period, ± 50 ps ADC aperture uncertainty. Crystal oscillator: 0°C to +70°C $V_{cc} = +5\text{ V} \pm 0.5\text{ V}$.
Dynamic Range	10.24 divisions.	

STORAGE DISPLAY

Vertical Resolution		1 part in 1024 (10 bit). Calibrated for 100 points per division.
Differential Accuracy	Graticule indication of voltage cursor difference is within 2% of LED readout value, measured over center six divisions.	

④ **UNCAL Indicator**—A LED that is illuminated when the VAR VOLTS/DIV control is out of the calibrated detent. It indicates that the vertical deflection factor is uncalibrated.

⑤ **POSITION Controls**—Control the vertical position of the channel displays on the crt both in storage and nonstorage modes. In the X-Y mode, the Channel 2 POSITION control adjusts the vertical positioning of the display.

⑥ **CH 1 or X and CH 2 OR Y Input Connectors**—Provide for application of external signals to the input of the vertical amplifiers. In the X-Y mode (A TIME/DIV switch set to X-Y), the signal applied to the CH 1 OR X connector provides horizontal deflection (X-axis), and the signal applied to the CH 2 OR Y connector provides vertical deflection (Y-axis).

These connectors each include a coding ring that activates the scale-factor-switching circuitry whenever a 10X scale-factor-switching probe is connected.

⑦ **Input Coupling Switches (AC-GND-DC)**—Select the method of coupling the input signal to the vertical deflection system.

AC position—Signals are capacitively coupled to the vertical deflection system. The dc component of the input signal is blocked.

DC position—All frequency components of the input signal are passed to the vertical input amplifier.

GND position—The input of the vertical amplifier is grounded to provide a ground reference and to allow the input coupling capacitor to be precharged to the input signal dc level through a high resistance connected to ground.

When operating in the NORM, ENVELOPE, or AVG Storage Mode, the ground reference is stored in the GND position and displayed as an intensified dot at the left edge of the graticule when the input coupling is switched to AC or DC. In ADD vertical mode, both CH 1 and CH 2 Input Coupling switches must be set to GND to store a ground reference.

Table 8 (cont)

Characteristics	Performance Requirements	Supplemental Information
DIGITAL STORAGE HORIZONTAL ACQUISITION		
Horizontal Resolution Single Waveform Acquisition		9 bit. 512 data points (50 data points per division across the graticule area).
Chopped Acquisition (NORM Storage Mode Only)		8 bit. 256 data points per division (25 data points per division across the graticule area).
Range		5 s per division to 20 ns per division in a 1-2-5 sequence. At TIME/DIV switch settings of 5 s to 2 μ s, waveform sampling rate is determined by the switch setting. From 1 μ s to 0.02 μ s per division, sampling rate is at the 2 μ s per division rate. Interpolation and analog gain are used to expand the signal to the correct horizontal scale.

In instruments equipped with firmware VERSION 1.0, at the end of the power-on routine, a random ground dot may be displayed. Switching the input coupling switch to GND will place the dot at a valid ground reference.

NOTE

If the Vertical POSITION control is adjusted after the ground reference is stored, the dot position is no longer a valid ground reference. Additionally, in firmware version 1.0, vertically expanding either waveform of a dual-channel storage display using the 2 mV, 1 mV, or 0.5 mV VOLTS/DIV switch position will cause an invalid ground dot display. A single-channel display ground dot remains valid during expansion.

In instruments factory equipped or converted to firmware version 2.0 or higher, the ground dot position remains valid as display vertical expansion occurs in a dual-channel display.

8 VERT MODE Switches—Five push-push switches, used to select the vertical mode of operation in both storage and nonstorage modes. The oscilloscope can display any combination of CH 1, CH 2, ADD, and A TRIG VIEW (external trigger only) in either Chopped

(CHOP) or Alternate (ALT) mode, when NON STORE is selected. The A TRIG VIEW mode is not functional in storage modes. If A TRIG VIEW is the only vertical mode selected or no vertical mode is selected when a storage mode push button is pressed in, the digital storage will continue to acquire and display the Channel 1 input signal, but all the probe coding LED (X1 and X10) are extinguished. The NON STORE display, with no vertical mode selected, will be a single, unpositionable baseline trace with no vertical deflection.

CH 1—Selects Channel 1 input signal for display or storage when push button is pressed in. To end the NON STORE display of the Channel 1 input signal, push CH 1 VERT MODE button to release it (Channel 1 remains selected in a storage mode if ADD or CH 2 vertical mode is not selected).

A TRIG VIEW—Displays the signal applied to the A External Trigger input connector when push button is pressed in, if the A TRIGGER SOURCE switch is set to either EXT or EXT/10. Remove the A External Trigger View trace from the display by pressing the A TRIG VIEW VERT MODE button to release it. The A TRIG VIEW display cannot be selected in any storage mode.

CH 2—Selects the Channel 2 input signal for display or storage when push button is pressed in. To end

Table 8 (cont)

Characteristics	Performance Requirements	Supplemental Information
HORIZONTAL DEFLECTION SYSTEM (cont)		
X-Y Operation (cont)		
Input Resistance	Same as vertical system. ^a	
Input Capacitance	Same as vertical system. ^a	
Maximum Usable Input Voltage	Same as vertical system. ^a	
Phase Difference Between X and Y Amplifiers		Within 3° from dc to 50 kHz.
Deflection Accuracy	Graticule indication is within 4% of true input voltage.	

the display of the Channel 2 input signal, push, CH 2 VERT MODE button to release it.

ADD—Selects the algebraic sum of Channel 1 and Channel 2 input signals to be displayed or stored when push button is pressed in. To end the display of the ADD signal, push the ADD VERT MODE button to release it.

CHOP-ALT:OUT (Nonstorage Mode)—When CHOP is selected (switch pressed in), the oscilloscope Vertical Switching circuitry is switched between two or more of the selected vertical modes at approximately a 500 kHz rate.

When ALT is selected (switch released out), the oscilloscope Vertical Switching circuitry is alternately switched between two or more of the selected vertical modes at the end of each sweep.

CHOP-ALT:OUT (Storage Mode)—When pressed in (CHOP) with the NORM Storage mode selected, the digital storage circuitry interleaves the Channel 1 and Channel 2 input signals into memory. Each channel is chopped to obtain 256 samples of each input signal. The storage chop rate is one half of the sampling rate of the selected sweep speed.

NOTE

For firmware version 1.0, and 2.0 a horizontal displacement of the displayed signal occurs between ALT and CHOP dual-channel acquisition. The displacement increases from approximately 0.1 division to approximately 1 division as the TIME/DIV switch setting is changed from 1 μ s to 0.02 μ s per division.

When either the ENVELOPE or AVG Storage mode is selected, the position of the CHOP-ALT:OUT switch has no effect on the storage; and Channel 1 and Channel 2 are alternately sampled to obtain 512 samples of each input signal.

When released out (ALT) with the NORM Storage mode selected, Channel 1 and Channel 2 are alternately sampled to obtain 512 samples of each input signal. However, if ADD Vertical mode is also selected, the ADD waveform is sampled 512 times alternately and Channel 1 and Channel 2 are chopped (256 samples each).

NOTE

CHOP and ALT functions are disabled if only one VERT MODE push button—CH 1, CH 2, ADD, or A TRIG VIEW (nonstorage only) is selected—or if X-Y mode is selected.

Table 8 (cont)

Characteristics	Performance Requirements	Supplemental Information
HORIZONTAL DEFLECTION SYSTEM (cont)		
Delay Time Jitter (Nonstorage Mode)	<p>One part or less in 50,000 (0.002% of 10 times the A TIME/DIV switch setting) when operating on an ac-power-source frequency above 50 Hz.</p> <p>One part of less in 20,000 (0.005% of A TIME/DIV switch setting) when operating on a 50 Hz or lower ac-power source frequency.^a</p>	
Calibrated Delay Time (VAR Control in Calibrated Detent)	Continuous from 0.2 μ s to at least 5 s after the delaying (A) sweep.	
X-Y Operation (Nonstorage Mode Only)		
X-Axis Deflection Factor	Same as vertical system, with X10 MAG off.	
Variable Range	Same as vertical system.	
X-Axis Bandwidth	Dc to at least 4 MHz.	10 division reference signal.

9 **20 MHz BW LIMIT (FULL BANDWIDTH OUT) Switch**—Limits the bandwidth of the vertical preamplifier to approximately 20 MHz when pressed in. Push button must be pressed a second time to release it and regain full 100 MHz bandwidth operation. This control has no affect on the digital storage signal acquisition even though the BW LIMIT LED may be illuminated.

10 **20 MHz BW LIMIT Indicator**—A LED that is illuminated to indicate that the bandwidth is limited to 20 MHz whenever the 20 MHz BW LIMIT push button is pressed in.

11 **INVERT**—Inverts Channel 2 display when push button is pressed in. Push button must be pressed a second time to release the button and return to a noninverted display of Channel 2.

DISPLAY AND CALIBRATOR

Refer to Figure 4 for location of items 12 through 19.

12 **Internal Graticule**—Eliminates parallax. Rise time amplitude measurement points are indicated at the left edge of the graticule.

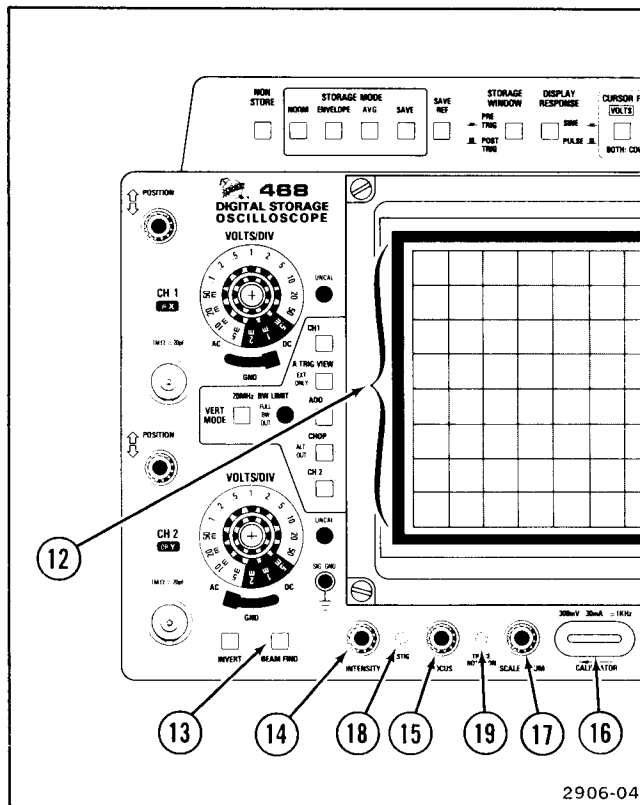

Figure 4. Display controls and CALIBRATOR.

Table 8 (cont)

Characteristics	Performance Requirements		Supplemental Information	
HORIZONTAL DEFLECTION SYSTEM (cont)				
POSITION Range (Horizontal)			Start of sweep must position to right of graticule center. End of sweep must position to left of graticule center.	
Differential Time Measurement Accuracy (Nonstorage Mode)	Measurements of 1 or more major dial divisions	Measurements of less than 1 major dial division	With the A TIME/DIV switch at 0.5 μ s per division, or 0.2 μ s per division, the differential time measurement accuracy limit is valid only for DELAY TIME POSITION dial settings between 1.50 and 8.50.	
	+15°C to +35°C	With 1% of indicated value.		± 0.01 major dial division.
	-15°C to +55°C	Within 2.5% of indicated value. ^a		± 0.03 major dial division. ^a

- ⑬ **BEAM FIND Switch**—When held in, the display is compressed to within the graticule area and a visible viewing intensity is provided to aid in locating off-screen displays.
- ⑭ **INTENSITY Control**—Determines the brightness of the crt display (has no effect when BEAM FIND switch is pressed in).
- ⑮ **FOCUS Control**—Adjusts for optimum display definition.
- ⑯ **CALIBRATOR Loop**—A combination 30 mA current loop and 0.3 v square-wave voltage output (at approximately 1 kHz) that permits the operator to compensate voltage and current probes and to check oscilloscope vertical operation. It is not intended to verify precise time-base calibration.
- ⑰ **SCALE ILLUM Control**—Adjusts graticule illumination.
- ⑱ **ASTIG Control**—Screwdriver control used in conjunction with the FOCUS control to obtain a well-defined display. It does not require readjustment during normal use of the instrument.

- ⑲ **TRACE ROTATION Control**—Screwdriver control used to align a baseline trace with the horizontal graticule lines.

TRIGGERING (both A and B if applicable)

Refer to Figure 5 for location of items 20 through 28.

- ⑳ **TRIG MODE Switches**—Three push-button switches that determine the mode of trigger operation for the instrument.

AUTO—Permits triggering on waveforms with a repetition rate of about 20 Hz or greater. Sweep free runs and provides a bright baseline when either an adequate trigger signal is absent, or if the repetition rate of the trigger signal is below 20 Hz. In a storage mode, the digital storage circuitry will acquire data from the selected time window and display the acquired data.

NORM—Sweep is initiated, or storage acquires data when an adequate trigger signal is applied. NORM Trigger Mode may be used to obtain stored waveforms to ensure that the time window the waveform is acquired from is synchronized with the triggering signal.

Table 8 (cont)

Characteristics	Performance Requirements	Supplemental Information
HORIZONTAL DEFLECTION SYSTEM (cont)		
Sweep Rate (cont) Two-Division Linearity Check		± 5% over any two-division portion (or less) of the full 10 divisions. When in X10 MAG exclude first and last magnified divisions when checking 2 ns, 5 ns, and 10 ns per division rates.
Alternate Sweep Trace Separation (Nonstorage Mode Only)		≥ ± 4 divisions.
Variable Range (A Only) (Nonstorage Mode)	Continuously variable between calibrated settings of the A TIME/DIV switch. Extends slowest A sweep rate to at least 1.25 s per division.	At least 2.5:1.
A Sweep Length (Nonstorage Mode)		10.5 to 11.5 divisions.
A Trigger HOLDOFF (Variable)		Increases A sweep holdoff time by at least a factor of 10 (Nonstorage Mode). Storage holdoff time is a function of microprocessor operation.
Magnifier Registration		Within 0.2 division from graticule center (X10 MAG on to X10 MAG off).

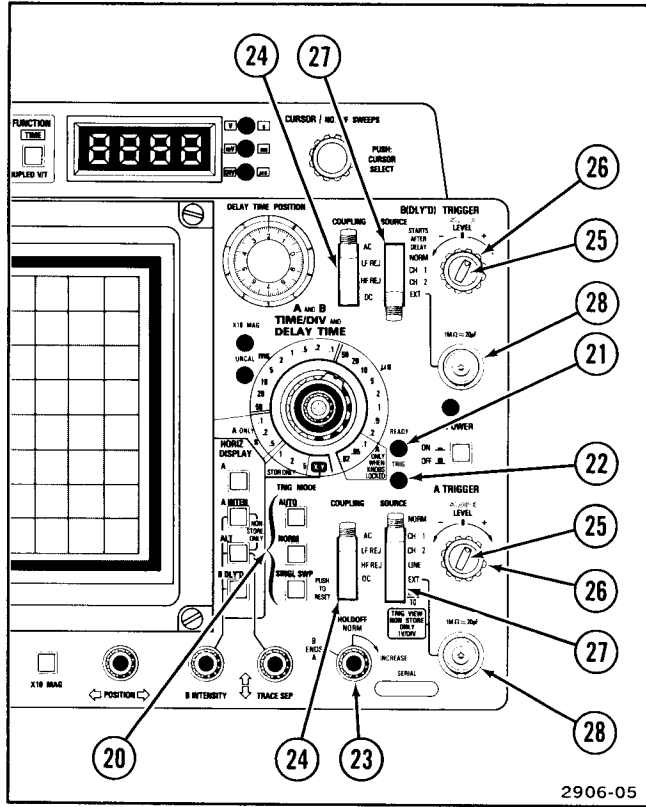

Figure 5. Trigger controls, connectors, and indicators.

SINGL SWP—Sweep is initiated one time (or one time window of data is stored) when an adequate trigger signal is applied. Sweep cannot be initiated again (or a new time window of data cannot be stored) until the sweep logic is reset by pressing the SINGL SWP push button. Stored data from the single time window will remain displayed on the crt.

Any front-panel control change that affects the data acquisition (VOLTS/DIV, VERT MODE, SEC/DIV, HORIZ MODE, etc.), requires that the SINGLE SWP push button be pressed again to obtain a valid display that agrees with the control setting. When storing displays that require two time windows to acquire, the SINGLE SWP push button must be pressed twice to obtain a valid display. If a valid display is not completed after a change affecting the acquisition timing, the TIME dot readout may switch between two different numbers at various settings of the SEC/DIV switch.

NOTE

Applying power to the instrument with either NORM or SINGL SWP Trigger Mode selected without a trigger signal present to acquire a waveform, will cause a dashed line to be displayed in any storage mode. The dashed line will be replaced by an acquired waveform when the instrument is adequately triggered.

Table 8 (cont)

Characteristics	Performance Requirements		Supplemental Information
HORIZONTAL DEFLECTION SYSTEM			
Sweep Rate (Nonstorage Mode) Calibrated Range A Sweep			0.5 s per division to 0.02 μ s per division in 23 steps in a 1-2-5 sequence. X10 MAG extends maximum sweep rate to 2 ns per division.
B Sweep			50 ms per division to 0.02 μ s per division in 20 steps in a 1-2-5 sequence. X10 MAG extends maximum sweep rate to 2 ns per division.
Accuracy +20°C to +30°C -15°C to +55°C	Within the given percentages of the indicated value.		Accuracy specification applies over the full 10 div of the unmagnified sweep.
	Unmagnified	Magnified	In X10 MAG, at TIME/DIV switch setting of .02 μ s, .1 μ s, and .2 μ s, exclude the first and last 50 ns of the sweep; and at a TIME/DIV switch setting of .5 μ s, exclude the first 100 ns of the sweep.
	Within 2%	Within 3%	
Within 3% ^a	Within 4% ^a		

In firmware version 1.0 instruments, the first SINGL SWP trigger received after power on or after a control change that affects the data being acquired is not considered valid. In either case, the SINGL SWP must be reset and a second trigger received before a waveform is stored and displayed. For instruments equipped with firmware version 2.0 and higher, the first SINGLE SWP trigger received is valid and a waveform will be stored and displayed.

- ②1 **READY Indicator LED**—Illuminates in the single-sweep mode to indicate that the sweep circuitry is armed and ready to initiate the sweep when a trigger signal occurs.
- ②2 **TRIG Indicator LED**—Illuminates to indicate the A Sweep is triggered.
- ②3 **A TRIG HOLDOFF Control**—Provides continuous control of holdoff time between sweeps. Allows triggering on aperiodic signals (such as complex digital words). In the fully clockwise position (B ENDS A), the A Sweep is automatically terminated at the end of the B Sweep to provide the fastest possible sweep repetition rate for delayed-sweep

presentations and low-repetition-rate signals. In the NON STORE mode, holdoff time is variable to approximately ten times NORM holdoff time. Use the A trigger controls to obtain as stable a display as possible before setting the A TRIG HOLDOFF control to a position other than NORM.

The variable holdoff capability is reduced in the storage modes due to the added digital holdoff time required for signal acquisition by the microprocessor.

- ②4 **COUPLING Switch**—Determines method used to couple a signal to the input of the trigger generator circuit.

AC—Signals are capacitively coupled to the input of the trigger circuit. The dc component is rejected, and signals below approximately 30 Hz are attenuated. Triggering is allowed only on the ac portion of the vertical signal.

LF REJ—Signals are capacitively coupled to the input of the trigger circuits. The dc component is rejected, and signals below approximately 50 kHz are attenuated. This position is useful for providing a stable display of the high-frequency components of a complex waveform.

Table 8 (cont)

Characteristics	Performance Requirements	Supplemental Information
TRIGGERING (cont)		
A External Trigger View (Nonstorage Mode Only)		
Deflection Factor EXT	100 mV per division +5%.	Dc trigger coupling only; checked with a 1 kHz signal.
EXT/10	1 V per division ±5%.	
Rise Time	5 ns or less. ^a	BW Limit at full (button out).
Delay Difference	≤ ±0.20 division (≤ ±300 ps at 2 ns per division).	5-division signal with 5 ns rise time or less from a 25 Ω source; centered vertically with equal 50 Ω cable length from signal source to vertical channel and external trigger input connectors; terminated in 50 Ω at each input.
Centering of Triggering Point		Within 1 division of center screen.
Flatness and Aberrations		+10%, -10%, 10% p-p.

HF REJ—Signals are capacitively coupled to the input of the trigger circuit. The dc component is rejected, and signals below approximately 30 Hz and above approximately 50 kHz are attenuated. This position is useful for providing a stable display of the low-frequency components of a complex waveform.

DC—All frequency components of a trigger signal are coupled to the input of the trigger circuit. This position is useful for providing a stable display of low-frequency or low-repetition-rate signals.

25 **SLOPE Switch**—Selects the slope of the signal that triggers the sweep.

+ (**plus**)—Sweep can be triggered from the positive-going portion of a trigger signal.

– (**minus**)—Sweep can be triggered from the negative-going portion of a trigger signal.

26 **LEVEL Control**—Selects the amplitude point on the trigger signal at which the sweep is triggered. This control is usually adjusted for the desired display after the Trigger SOURCE, COUPLING, and SLOPE have been selected.

27 **SOURCE Switch**—Selects the source of the trigger signal coupled to the input of the trigger circuit.

NORM—The waveform displayed on the crt is the source of a composite trigger signal. Stable triggering of non-time-related signals usually can be obtained by setting VERT MODE to ALT, SOURCE to NORM, COUPLING to LF REJ (high-frequency signals only), and adjusting the Trigger LEVEL control for a stable display. Time relationship between the Channel 1 signal and the Channel 2 signal is not indicated by the display.

CH 1—The signal applied to the CH 1 input connector is the source of the trigger signal. Channel 2 signal display is unstable if it is not time related to the Channel 1 signal.

CH 2—The signal applied to the CH 2 input connector is the source of the trigger signal. The Channel 1 signal display is unstable if it is not time related to the Channel 2 signal.

LINE (in the A Sweep Trigger circuitry only)—The ac-power-source waveform is the source of the trigger signal. This position is useful when the input signal is time related (multiple or sub-multiple) to the frequency of the ac-power source or when it is desirable to provide a stable display of a power-

Table 8 (cont)

Characteristics	Performance Requirements	Supplemental Information
TRIGGERING (cont)		
Trigger Jitter		
Nonstorage Mode	0.5 ns or less at 100 MHz at 2 ns per division (X10 MAG on).	
Storage Mode	± 1 sample period for data transmitted on the GPIB. See Jitter Correction Performance Requirement. ^a	Inherent ± 1 sample jitter between sample clock and asynchronous trigger is partially compensated for by the jitter correction circuitry.
External Trigger Inputs		
Maximum Input Voltage	250 V (dc + peak ac). ^a 250 V (p-p ac at 1 kHz or less). ^a	
Input Resistance	1 M Ω within 10%. ^a	
Input Capacitance		Approximately 20 pF, within 30%.
LEVEL Control Range		
EXT	At least + and -2 V, 4 V p-p.	
EXT/10	At least + and -20 V, 40 V p-p.	

source frequency component in a complex waveform.

EXT—The signal connected to the External Trigger Input connector is used for triggering. External signals must be time related to the displayed signal for a stable display. This position is useful when the internal signal is either too small or contains undesired components that cause unstable triggering. The external trigger signal may be viewed by pushing the A TRIG VIEW button in only when the 468 is operating in the NON STORE mode. The A TRIG VIEW display is not selectable in any storage mode.

EXT/10 (in the A Sweep Trigger circuit only)—External trigger signal is attenuated by a factor of 10.

STARTS AFTER DELAY (in the B Sweep Trigger circuit only)—B Sweep starts immediately after the delay time selected by the DELAY TIME POSITION control. In this position, the B Sweep is independent of the B trigger signal. When making differential time measurements with the 468 in the NON STORE Mode, this position of B Trigger SOURCE switch must be selected for valid measurements.

- 28 **External Trigger Input Connectors**—Provide for application of external triggering signals to the A TRIGGER and B (DLY'D) TRIGGER circuits, when either EXT or EXT/10 (A Trigger only) SOURCE is selected.

HORIZONTAL AND POWER

Refer to Figure 6 for location of items 29 through 35.

- 29 **A and B TIME/DIV Switches**—Select the calibrated sweep rates in the non-storage mode and the time window for the storage modes.

Nonstorage Mode—The A TIME/DIV switch selects 23 calibrated sweep rates and delay times from 0.5 s to 0.02 μ s per division in a 1-2-5 sequence. Extreme counterclockwise position of the switch selects the X-Y horizontal display.

The B TIME/DIV switch selects calibrated sweep rates from 50 ms to 0.02 μ s per division in a 1-2-5 sequence.

Storage Mode—The A or B TIME/DIV switch selects the time window to be acquired (10 divisions multiplied by the TIME/DIV switch setting) for

Table 8 (cont)

Characteristics	Performance Requirements	Supplemental Information
TRIGGERING		
Sensitivity AC Coupled Signal	0.3 division internal or 50 mV external from 30 Hz to 10 MHz; increasing to 1.5 divisions internal or 150 mV external up to 100 MHz.	In EXT/10, multiply requirements by 10.
LF REF Coupled Signal	0.5 division internal or 100 mV external from 50 kHz to 10 MHz; increasing to 1.5 divisions internal or 300 mV external up to 100 MHz.	Attenuates signals below approximately 50 kHz.
HF REJ Coupled Signal	0.5 division internal or 100 mV external from 30 Hz to 50 kHz.	Attenuates signals above approximately 50 kHz.
DC Coupled signal	0.3 division internal or 50 mV external from dc to 10 MHz; increasing to 1.5 divisions internal or 150 mV external up to 100 MHz.	

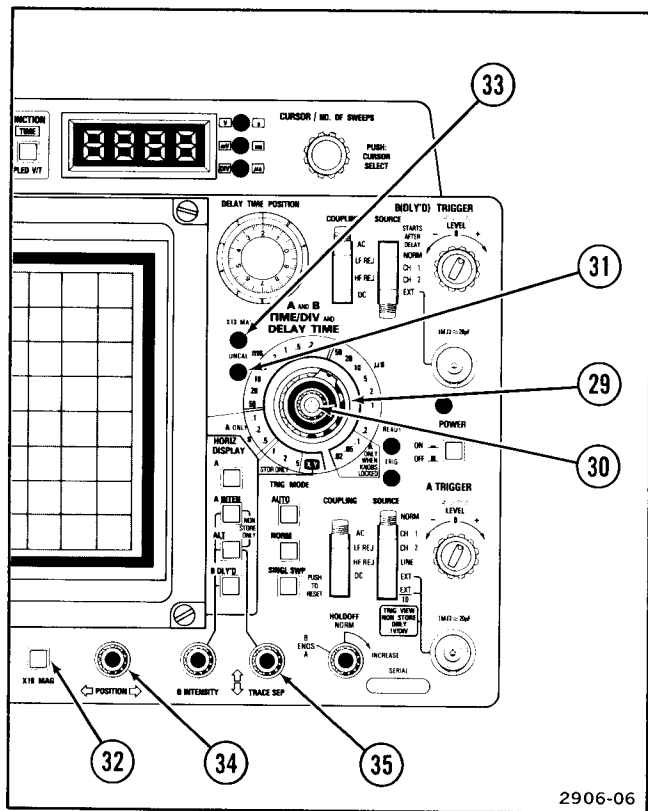

Figure 6. Sweep rate and position controls and indicators.

TIME/DIV switch settings between $0.02 \mu\text{s}$ and 5 s per division. Sampling of the analog input signal is done 512 times during one full sweep time (50 in 1 division). Rate of sampling is calculated by dividing the number of samples in 1 division by the sweep time for 1 division:

$$\text{Sample rate} = \frac{50 \text{ samples}}{\text{TIME/DIV}}$$

For TIME/DIV switch settings from $1 \mu\text{s}$ per division to $0.02 \mu\text{s}$ per division, a waveform is sampled at the $2 \mu\text{s}$ per division rate and expanded horizontally, using a combination of digital interpolation and analog gain, to the correct horizontal scale.

The A TIME/DIV switch selects the time for A and A INTEN Horizontal Displays, and the B TIME/DIV switch selects the time for ALT and B DLY'D Horizontal Displays. The 1, 2, and $5 \mu\text{s}$ per division positions of the A TIME/DIV switch are used in the storage modes only. The X-Y position of the A TIME/DIV switch is not used in any storage mode.

The SAVE display of a stored waveform acquired at $2 \mu\text{s}$ per division and slower may be expanded up to 100 times using the next six faster positions of the TIME/DIV switch associated with the selected Horizontal Display Mode. Waveforms acquired at $1 \mu\text{s}$ per division and faster are expanded by

Table 8 (cont)

Characteristics	Performance Requirements		Supplemental Information
DIGITAL STORAGE VERTICAL ACQUISITION (cont)			
Useful Storage Bandwidth (cont) PULSE Display Response	Dc to 3.5 MHz, within +0.5, -1.5 dB, measured p-p over any single cycle, with TIME/DIV switch set to 0.2 μ S (X10 MAG off).	Dc to 1.75 MHz, within +0.5, -1.5 dB, measured p-p over any single cycle, with TIME/DIV switch set to 0.2 μ S (X10 MAG off).	For PULSE Display Response, useful storage bandwidth is limited to that frequency where there are 7 samples per input cycle period at the maximum sampling rate (max sampling rate is 25 MHz in Single Trace or ALT and 12.5 MHz in CHOP). Accuracy at useful storage bandwidth limit is measured with respect to a 6-division, 50 kHz reference sine wave.
Useful Storage Rise Time NORM Storage Mode PULSE Display Response	64 ns.	128 ns.	Useful storage rise time is defined as 1.6 times the minimum sampling interval (40 ns in Single Trace or ALT and 80 ns in CHOP).

each of the remaining faster positions of the TIME/DIV switch. Additionally, waveforms acquired at 1 μ s per division and faster may be reduced back to the 2 μ s per division sweep rate in the steps of the TIME/DIV switch.

30) A Sweep VAR Control—Provides continuously variable uncalibrated A Sweep rates to at least 2.5 times the calibrated setting (extends slowest NON STORE sweep rate to at least 1.25 s per division). This control is effective only in the NON STORE mode.

31) UNCAL Indicator LED—Illuminates to indicate that the A time base sweep rate is uncalibrated (VAR control is out of calibrated detent).

In the storage modes the VAR control is ignored, and the UNCAL LED is not illuminated when the VAR control is out of calibrated detent. The storage time base is obtained from the setting of the TIME/DIV switch associated with the selected Horizontal Display mode.

32) X10 MAG Switch—When pressed in, increases the displayed sweep rate by a factor of 10. Extends the fastest sweep rate to 2 ns per division. The magnified sweep expands the center division of the unmagnified

display (0.5 division either side of the center vertical graticule line).

33) X10 MAG Indicator LED—Illuminates when the X10 MAG push button is in to indicate that the horizontal display is magnified.

34) POSITION Control—Positions the display horizontally for both nonstorage and storage modes. Provides both coarse and fine control action. Reverse the direction of rotation to actuate fine positioning action.

35) TRACE SEP Control—Positions the B Sweep vertically when the ALT horizontal display mode is selected. TRACE SEP has no effect on the stored display.

Refer to Figure 7 for location of items 36 through 40.

36) B INTENSITY Control—Controls the intensity of the B trace and interacts with INTENSITY control. The B INTENSITY control has no effect when a storage mode is selected.

Table 8 (cont)

Characteristics	Performance Requirements		Supplemental Information
DIGITAL STORAGE VERTICAL ACQUISITION (cont)			
Analog Bandwidth	Dc to 10 MHz, with ± 1 dB, measured in ENVELOPE Storage Mode with the TIME/DIV switch set to 1 ms.		At exactly 10 MHz input signal frequency, it is possible for aliasing to occur and produce an envelope with variable amplitude. If aliasing occurs, shift the test frequency slightly to obtain an envelope with flat amplitude.
Useful Storage Bandwidth NORM Storage Mode SINE Display Response	Single Trace or Alt	CHOP	For SINE Display Response, useful storage bandwidth is limited to that frequency where there are 2.5 samples per input cycle period at the maximum sampling rate (max sampling rate is 25 MHz in Single Trace or ALT and 12.5 MHz in CHOP). Accuracy at useful storage bandwidth limit is measured with respect to a 6 division, 50 kHz reference sine wave.
	Dc to 10 MHz, with +1, -3 dB, measured p-p over any single cycle, with TIME/DIV switch set to 0.2 μ s (X10 MAG off).	Dc to 5 MHz, with-in +0.5, -1.5 db, measured p-p over any single cycle, with TIME/DIV switch set to 0.2 μ s (X10 MAG off).	

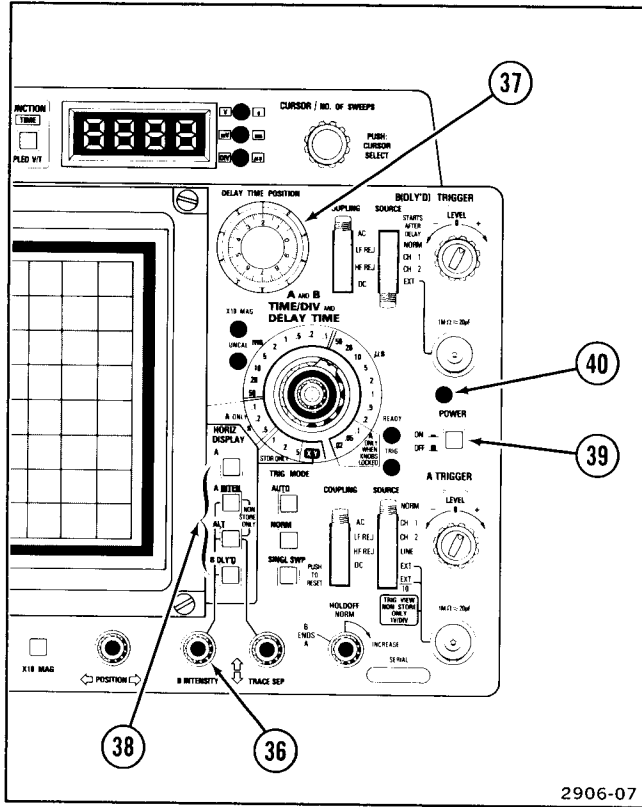

Figure 7. Horizontal display, B INTENSITY, DELAY TIME POSITION, and power controls and indicator.

37 DELAY TIME POSITION Control—Selects the amount of delay time between the start of the A Sweep and the start of the B Sweep. Delay time is variable to at least 10 times the A TIME/DIV switch setting. This control is used in conjunction with the STARTS AFTER DELAY position of the B TRIGGER SOURCE switch.

38 HORIZ DISPLAY Switches—Select the mode of operation for the horizontal deflection system.

A—Displays only the A Sweep. The digital storage time base and the horizontal deflection rate are determined by the setting of the A TIME/DIV switch.

A INTEN—Displays the A Sweep at a rate determined by the setting of the A TIME/DIV switch. An intensified portion corresponding to the length and position of the B Sweep will appear on the trace when the B Sweep is properly triggered. The INTENSITY and B INTENSITY controls should be adjusted to obtain the proper brightness for viewing. The intensified zone is used to position the B Sweep (delayed) to the desired location within the A Sweep interval to obtain an expanded view of a waveform for examination.

Table 8 (cont)

Characteristics	Performance Requirements	Supplemental Information
DIGITAL STORAGE VERTICAL ACQUISITION		
Resolution		8 bits, 25 levels per division. 10.24 divisions dynamic range.
DC Accuracy	Scaled binary value of stored digital word is within 3% of true input voltage up to ± 12 divisions, referenced to instrument ground, for all calibrated VOLTS/DIV switch settings.	Gain set with VOLTS/DIV set to 5 mV per division.
Range		0.5 mV to 5 V per division in a 1-2-5 sequence of 13 steps.
Digital Sample Rate		10 Hz to 25 MHz as determined by the TIME/DIV switch setting.
Digital Chop Rate		5 Hz to 12.5 MHz (1/2 of the non-chopped sample rate at all TIME/DIV switch settings).
Analog Step Response	3% or less acquired overshoot on a 5-division pulse with Display Response set to PULSE.	Checked on a saved waveform display using horizontal expansion (X10 MAG off).

The digital storage time base is determined by the setting of the A TIME/DIV switch in the A INTEN Horizontal Display mode.

ALT—Alternates the display between the A INTEN and B DLY'D sweeps. The TRACE SEP control will position the B display vertically. In the nonstorage mode, the B INTENSITY control will adjust the intensity of the B Sweep whenever it is displayed. The digital storage circuitry time base is determined by the setting of the B TIME/DIV switch.

B DLY'D—Displays only the B Sweep. The B Sweep rate is determined by the setting of the B TIME/DIV switch, and the delay time is determined by both the A TIME/DIV switch and the DELAY TIME POSITION control. The digital storage circuitry time base is determined by the setting of the B TIME/DIV switch.

39 POWER Switch—A push-push switch used to turn instrument power on and off. It must be pushed in to apply power to the instrument and pushed in again to release the switch and remove power from the instrument.

40 Power On Indicator LED—Illuminates when power is applied to the instrument and POWER switch is set to the "on" (in) position.

DIGITAL STORAGE

Refer to Figure 8 for location of items 41 through 49.

41 NON STORE Switch—Selects operation as a conventional oscilloscope. Any data stored in the 468 digital storage memory remains unchanged while NON STORE is selected. The last acquired waveform data may be transmitted via the optional IEEE-488 GPIB interface during NON STORE. While transmitting, the 468 switches to the SAVE Storage Mode to display the waveform being transmitted. At the completion of a transmission the oscilloscope returns to the selected operation. The AVG waveform data cannot be transmitted from the NON Store Mode unless a completed waveform was saved prior to selecting NON STORE. Switching directly from AVG to NON STORE will abort the AVG acquisition cycle in progress, and an attempt to transmit will result in sending only the instrument ID.

Table 8 (cont)

Characteristics	Performance Requirements	Supplemental Information
VERTICAL SYSTEM (cont)		
Input R and C		
Resistance	1 M Ω , within 2%. ^a	
Capacitance	Approximately 20 pF. ^a	Within 3%.
R and C Product (+20°C to +30°C)		Aberrations 2% or less using a P6105 probe.
Maximum Input Voltage DC Coupled	250 V (dc + peak ac). ^a 500 V (p-p ac at 1 kHz or less). ^a	
AC Coupled	250 V (dc + peak ac). ^a 500 V (p-p ac at 1 kHz or less). ^a	
Cascaded Operation		CH 1 VERT OUT SIGNAL OUT coupled into CH 2 input; ac coupled, using 50 Ω , 42-inch RG-58 C/U cable, terminated in 50 Ω at the CH 2 input connector.
Bandwidth (Nonstorage)	Dc to at least 50 MHz.	
Cascaded Sensitivity	At least 1 mV per division; terminated in 50 Ω at the CH 2 input connector.	

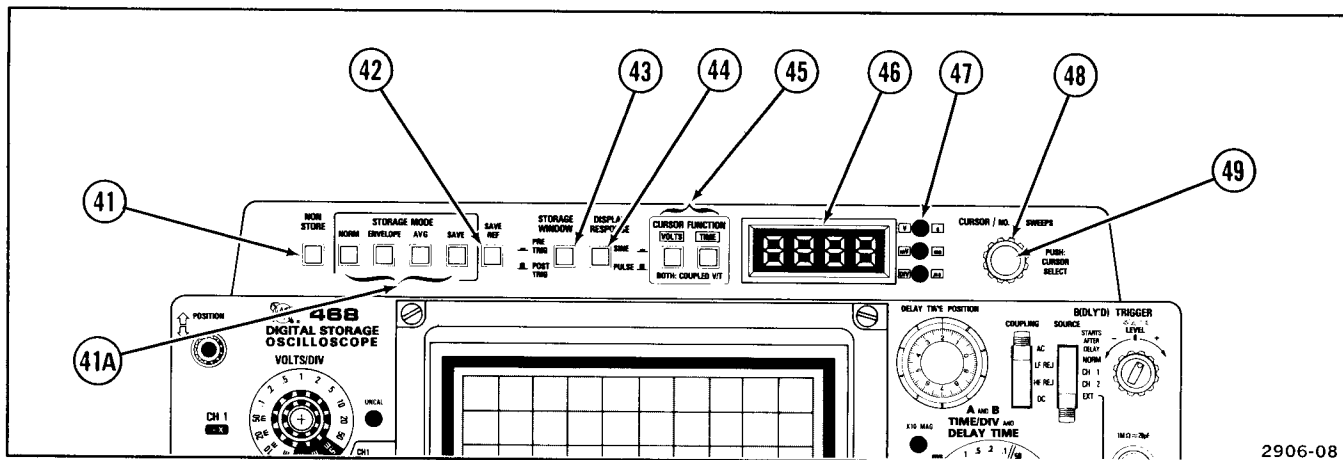

Figure 8. Digital storage controls and indicators.

41A STORAGE MODE Switches—Select storage mode operation. Selection of a switch cancels the remaining switches.

NORM (Normal)—In this mode, the 488 digitizes, stores, and displays data from Channel 1 and Channel 2 at the vertical gain and horizontal sweep speed determined by the oscilloscope front-panel Vertical and Horizontal controls. If the oscilloscope

TRIG MODE is SINGL SWP, data will be acquired for that sweep and displayed. If the TRIG MODE is AUTO or NORM, data will be repetitively acquired and displayed.

ENVELOPE—The ENVELOPE mode is a repetitive mode that acquires a selected number of sweeps and displays the resultant waveform envelope. Each data point of the input waveform is compared

Table 8 (cont)

Characteristics	Performance Requirements	Supplemental Information
VERTICAL SYSTEM (cont)		
INVERT Trace Shift Input Gate Current +20°C to +30°C		Less than 2 divisions when switching from non-inverted to inverted. 0.5 nA or less (0.1 division or less trace shift when switching input coupling between dc and GND with VOLTS/DIV switch set to 5 mV per division).
-15°C to +55°C		4 nA or less (0.8 division or less trace shift when switching input coupling between dc and GND with VOLTS/DIV switch set to 5 mV per division).
Channel Isolation		At least 100:1 at 25 MHz (10 MHz in storage).
Vertical POSITION Range		At least +12 and -12 divisions from graticule center.
Chopped Mode Repetition Rate (Nonstorage Mode)	Approximately 500 kHz.	Within 20%

to the maximum and minimum values of the same data point accumulated from previous sweeps. If the data point is greater than the previous maximum or less than the previous minimum for that data point, the previous data point is replaced by the new data point. If the data point does not meet one of the conditions mentioned, it is discarded.

The ENVELOPE accumulation cycle is restarted whenever any of the following events occurs; the ENVELOPE push button is pressed in, the selected number of sweeps to be accumulated is changed, or any of the front-panel controls affecting the data being acquired is changed (VERT MODE VOLTS/DIV, STORAGE WINDOW, TIME/DIV, HORIZ DISPLAY, or VAR in and out of detent). A new cycle is also started upon completion of the current cycle.

At TIME/DIV switch settings slower than 20 μ s per division, the analog input will be sampled every 200 ns. Only the maximum and minimum values over every data point time interval (4% of the TIME/DIV switch setting) are stored in the digital storage memory.

The number of waveforms to be accumulated to develop the display is selectable in a binary sequence of (1, 2, 4, ...) up to 256 sweeps. Press in

the NO. OF SWEEPS push button and use the CURSOR/NO. OF SWEEPS control to obtain a new number of sweeps to be accumulated (number is displayed on the LED indicators). An unlimited number of sweeps may also be selected (LED display is 9999), and the digital storage memory will repeatedly acquire data until either a new "number of sweeps" selection is made or a control setting is changed to restart the accumulation of data. The NO. OF SWEEPS push button must be pressed again to release it and return the readout to cursor control. During the first ENVELOPE cycle, the readout will count down the sweeps as they are being acquired. Thereafter, the readout returns to cursor control. The readout will not count down when an unlimited number of sweeps is selected.

At power on, the number of sweeps to be accumulated is automatically set to 32.

AVE (Average) (Option)—When equipped with this option, the 468 will average the input signal for a selected number of sweeps and display the accumulated waveform. The number of sweeps to be averaged may be altered (from the power on number of 32) by pressing the NO. OF SWEEPS push button to display the number and adjusting the CURSOR/NO. OF SWEEPS control to obtain a new number from 2 to 256 in a binary sequence.

Table 8 (cont)

Characteristics	Performance Requirements	Supplemental Information
VERTICAL SYSTEM (cont)		
Step Response (cont) Position Effect 0°C to +40°C		Total aberrations less than +6%, –6%, 6% p-p; checked at 5 mV per division.
Negative-Going Step		Add 2% to all positive-going specifica- tions; checked at 5 mV per division.
ADD Mode Operation		Add 5% to all aberration specifica- tions; checked at 5 mV per division.
Common Mode Rejection Ratio (ADD Mode With Channel 2 Inverted)		At least 10:1 at 20 MHz for common mode signals of 6 divisions or less with GAIN adjusted for best CMRR at 50 kHz. (10:1 at 10 MHz for storage mode.)
Trace Shift as VAR VOLTS/DIV Control Is Rotated		1 division or less. Digital Storage scale-factor LED will indicate voltage measurements are in divisions in a storage mode with the VAR control out of calibrated detent.

The NO. OF SWEEPS push button must be pressed again to release it and return the readout to cursor control. Upon releasing the NO. OF SWEEPS push button, the readout will count down the sweeps as they are being acquired during the first average cycle only. Thereafter, the readout returns to cursor control.

The AVG accumulation cycle is restarted whenever the AVG push button is pressed in, whenever the selected number of sweeps is changed, or if any of the front-panel controls affecting the data being acquired is changed (VERT MODE, VOLTS/DIV, TIME/DIV, STORAGE WINDOW, HORIZ DISPLAY, or VOLTS/DIV VAR in and out of detent).

After a control setting change, and before an AVG acquisition is completed that reflects the new control setting, a dashed line will be displayed. The dashed line will be replaced by the AVG waveform upon completion of the current cycle, and a new acquisition cycle will begin. A SAVE REF waveform will remain displayed as acquired during any control setting changes.

SAVE—Pressing the SAVE push button in when NORM Storage Mode is selected will stop acquisi-

tion of data, and the displayed waveform will be saved. When either ENVELOPE or AVG Storage Mode is selected, the acquisition cycle in progress will be completed, and the new waveform will be saved. A cycle is defined as the selected number of sweeps in the ENVELOPE and AVG Storage Modes. In the ENVELOPE Storage Mode, if the number of sweeps selected is set to 9999, pressing the SAVE push button will switch the digital storage to the SAVE Storage Mode at the end of the current sweep.

If a dual-trace display is in use, the action that occurs before entering the SAVE Storage Mode after the SAVE button is pressed differs for ENVELOPE and AVG Storage Modes. Since the ENVELOPE display is updated with each sweep alternately, both waveforms will complete the selected number of sweep acquisitions before the SAVE Storage Mode is entered. The AVG display must complete the cycle, acquiring all the sweeps selected for a trace, before that trace is updated. Therefore, for the AVG display, only the waveform being acquired at the time the SAVE button is pressed in will be completed before entering the SAVE Storage Mode.

Table 8 (cont)

Characteristics	Performance Requirements	Supplemental Information
VERTICAL SYSTEM (cont)		
Frequency Response (cont) AC Coupled Lower -3 dB Point 1X Probe	10 Hz or less.	
10X Probe	1 Hz or less.	
Step Response (Non-Storage Mode) Risetime 0°C to +40°C	3.5 ns or less (calculated). ^a	5-division reference signal, dc coupled at all deflection factors, from a 25 Ω source; vertically centered with VAR VOLTS/DIV control in calibrated detent. Rise Time = $\frac{0.35}{\text{BW (in MHz)}}$
Positive-Going Step (Excluding ADD Mode) Aberrations 0°C to +40°C		+4%, -4%, 4% p-p or less. +6%, -6%, 6% p-p or less (5 V setting only).

NOTE

In the event that the storage modes are selected in the following order: AVG, NON STORE, then back to SAVE; the SAVE display will not be valid and a dashed line will be displayed. Switching from NON STORE to SAVE will display the last waveform acquired in either NORM or ENVELOPE Storage Mode.

Additional, in firmware version 1.0, changing the number of sweeps to be averaged in a dual-channel storage display and then switching to SAVE Storage Mode before the waveform has been acquired at least one time at the new NO. OF SWEEPS setting will prevent a valid expansion (both vertical and horizontal) of one of the waveforms. Instruments equipped with firmware version 2.0 or higher will display the valid acquired waveform only and the display can be expanded normally.

- 42 **SAVE REF**—Pressing in the SAVE REF push button will save one waveform for the purpose of comparing it with waveforms stored later. If more than one VERT MODE is selected, the waveform stored as a reference is in the following priority: ADD, CH 1, then CH 2. If a chopped display of CH 1 and CH 2 is selected, then both traces will be saved as a reference; but if ADD Vertical mode is selected as well, the ADD display will be saved as a reference; but if ADD Vertical

mode is selected as well, the ADD display will be saved as a reference. See Table 3 in “Digital Storage Displays” for a complete listing of references saved and displays available with various selections of Vertical and Storage modes. The number of VERT MODE selections that may be simultaneously displayed is reduced while the SAVE REF display is selected.

NOTE

If power is applied in a storage mode with the SAVE REF push button pressed in, a residual waveform from the power-on self test will remain displayed. Remove the residual waveform by pressing the SAVE REF push button to release it.

Additionally, in firmware version 1.0, when powering on with the TIME/DIV switch set slower than 2 μ s per division, a TIME cursors readout will oscillate. Again, release the SAVE REF push button to eliminate the condition.

Selecting SAVE REF when a chopped dual-channel acquisition is being made, causes the Channel 2, X1 and X10 probe coding LED to be extinguished. The SAVE REF push button must be released to reilluminate them.

Table 8 (cont)

Characteristics	Performance Requirements	Supplemental Information
VERTICAL SYSTEM (cont)		
Deflection Factor (cont) Uncalibrated (VAR) Range (Nonstorage Mode)	Continuously variable between settings of VOLTS/DIV switch. Extends deflection factor to at least 12.5 V per division.	
Low-Frequency Linearity		0.1 division or less compression or expansion of a 2-division signal at center screen with waveform positioned to upper and lower extremes of graticule area.
Frequency Response Bandwidth (Channel 1 and Channel 2 Nonstorage Mode)	Dc to at least 100 MHz.	5-division reference signal from a 25 Ω source; centered vertically, with VAR VOLTS/DIV control in calibrated detent.
-15°C to +40°C	Dc to at least 100 MHz.	
+40°C to +55°C	Dc to at least 85 MHz. ^a	

In instruments equipped with firmware version 2.0 or higher, both the TIME cursor readout oscillation and the Channel 2 probe-coding LED operation anomalies do not exist.

43 STORAGE WINDOW (PRE TRIG or POST TRIG)—Selects pretrigger or post-trigger storage of data. When pressed in (pretrigger), approximately 8.75 divisions of the waveform are stored before the trigger event. When out (post-trigger), approximately 1.25 divisions of the waveform are stored before the trigger event.

44 DISPLAY RESPONSE (SINE or PULSE)—Controls the interpolation applied to the displayed data at TIME/DIV switch settings from 1 μ s per division to 0.02 μ s per division only. When pressed in (SINE), interpolation is applied that optimizes the display accuracy for waveforms containing no frequency components above 10 MHz. When out (PULSE), linear interpolation is applied to optimize the display accuracy for fast-rise and fast-fall waveforms (rise time or fall time less than 6% of the TIME/DIV switch setting) and to eliminate overshoot. The SINE and PULSE Display Response will affect the SAVE Storage mode display. Switching from one to the other will change the interpolation method applied to the displayed waveform.

45 CURSOR FUNCTION—Two push-push switches used to select the cursors (VOLTS or TIME) to be displayed on the crt. Cursors are used to select measurement points on the displayed waveform. Voltage and time differences between the cursors are displayed on the four-digit, seven segment LED indicators.

VOLTS—When pressed in, cursors displayed consist of two horizontal lines that may be positioned vertically to any location on the crt. The cursor selected to be active is dashed. LED indicators display the voltage difference (represented by the cursor positions) based on the VOLTS/DIV setting of the channel used to obtain the stored waveform. If the VAR control is out of the calibrated detent during acquisition of the signal, the scale factor LED will indicate that the measurement is in divisions rather than voltage units. Press the push button again to release it and remove the VOLTS cursors from the displays.

TIME—When pressed in, the displayed cursors are two bright dots on the trace that may be positioned anywhere on the displayed waveform. The seven-segment LED indicators display the time difference between the dots as determined by the TIME/DIV switch setting for the selected time base. In the SAVE Storage Mode, time dots will appear on all the traces simultaneously, with the exception of

SPECIFICATION

The following electrical characteristics (Table 8) are valid only if the instrument has been calibrated at an ambient temperature between +20°C and +30°C, the instrument is operating at an ambient temperature between -15°C and +55°C (unless otherwise notes), and the instrument has had a warmup period of about 20 minutes.

Environmental characteristics are given in Table 9. The 468 meets the requirements of MIL-T-28800B, Class 3, Style D equipment. Physical characteristics are listed in Table 10, and option electrical characteristics are presented in Table 11.

Table 8
ELECTRICAL CHARACTERISTICS

Characteristics	Performance Requirements	Supplemental Information
VERTICAL SYSTEM		
Deflection Factor (Nonstorage Mode) Range		5 mV per division to 5 V per division in a 1-2-5 sequence of 10 steps.
DC Accuracy	Graticule indication is within 3% of true input voltage up to ± 12 divisions, referenced to instrument ground, for all calibrated VOLTS/DIV switch settings.	Gain set with VOLTS/DIV switch set to 5 mV per division.

the SAVE REF waveform. Press the push button again to release it and remove the time dots from the display.

NOTE

In instruments with firmware versions 1.0 and 2.0, the TIME cursor dots can be positioned off the left end of the traces in a SAVE display of the combined CH 1, CH 2, and ADD traces. The TIME dots will remain visible on the ADD trace unless the display is expanded horizontally.

BOTH: COUPLED V/T—Pressing the Volts and TIME push buttons in together causes the voltage cursors to couple to the time dots. The coupled cursors may be positioned to any location on the displayed waveform. If more than one VERT MODE is selected, the coupled cursors may be used with only one waveform, determined by the following priority: ADD, CH 1, then CH 2.

In instruments containing firmware version 2.0 or higher, rotating the cursor knob fully counterclockwise into the end-stop spring and holding it, will cause the dashed VOLTS cursor to attach to a previously acquired ground dot. Rotating the con-

trol clockwise will detach the VOLTS cursor from the ground dot and reattach it to the time dot on the displayed waveform. In certain instances, the VOLTS cursor may not attach to the ground dot. If this occurs, require a valid ground dot. The VOLTS cursor will then attach to the ground dot as previously described.

While in the COUPLED V/T mode, the seven-segment LED indicators will display the voltage difference between the VOLTS cursors.

Pressing the VOLTS push button to release the 468 from the COUPLED V/T measurement mode will switch the 468 to the TIME measurement mode, and the seven-segment LED indicators will display the time period between the time cursor dots. Time cursors will remain as set in COUPLED V/T.

Pressing the TIME push button to release the 468 from the COUPLED V/T measurement mode will switch the 468 to the VOLTS measurement mode, and the voltage cursors will return to the position they were in before the COUPLED V/T selection was made.

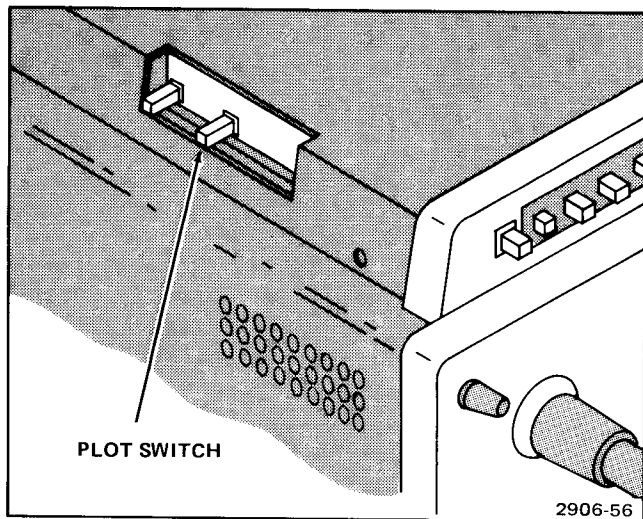

Figure 54. Location of Analog X-Y Output PLOT switch.

Only the actual waveform data points are output to the X OUT and Y OUT connectors. No scale factors or interpolated data are sent. When the PLOT push button is pressed, the plotter pen will move to the first data point after about two seconds. The pen will stay at the first data point for five seconds. After 2.5 seconds, the plotter pen will be lowered to the plot paper. The remaining data points will be plotted at the rate selected by the PLOT SPEED switch. On the last data point plotted, the pen again remains for five seconds, with the pen lifting at about 2.5 seconds into the delay. The five-second delay at the first and last data points allows the operator time to manually control the pen position on some X-Y Plotters. For multiple waveforms to be plotted, the sequence just described is repeated for each waveform, including a two-second wait in the home position before going to the first data point of the next waveform to be plotted. When all the waveform data has been sent, the 468 returns to front-panel control.

46 LED INDICATORS—Four-digit, seven-segment LED indicators used to display the measurements made on the stored waveform. The LED indicators also display error messages that are generated in the event that an error is detected during the self-test that is performed when power is first applied to the 468. In the NON STORE mode, the LED indicators will not be illuminated after the self-test is completed unless an error message is being displayed.

47 Scale-Factor Indicators—Three dual-color LEDs (red and green under a single lens) used to indicate the scale (V, mV, and DIV; or s, ms, and μ s) and the function (red illuminates for V, mV, and DIV measurements; green illuminates for s, ms, and μ s measurements).

The DIV scale-factor LED will be illuminated when either both CH 1 and CH 2 are selected or the ADD mode is selected, and the CH 1 and CH 2 VOLTS/DIV switches are set differently. If either VOLTS/DIV VAR control is out of calibrated detent, the DIV LED will illuminate when the VOLTS cursors are selected.

48 CURSOR/NO. OF SWEEPS Control—Combined slow and fast cursor positioning control used to change the position of the selected cursor on the displayed trace.

The midrange rotation of the control moves the selected cursor linearly at the slow rate. When the control is rotated into the end-point stop spring, the cursor rate of travel increases to quickly move the cursor to the point of interest.

When the instrument is equipped with the AVG Storage Mode option, this control is used to select the number of sweeps to be averaged. In the ENVELOPE Storage mode, the control is used to set the number of sweeps to be accumulated in the envelope display. While the NO. OF SWEEPS push button is pressed in, rotating the control to the clockwise stop will increase the number of sweeps, and rotating the control to the counterclockwise stop will decrease the number of sweeps. Releasing the NO. OF SWEEPS push button returns the control to its CURSOR positioning function.

49 PUSH: CURSOR SELECT—A momentary contact switch (concentric within the CURSOR/NO. OF SWEEPS control knob) used to alternately select the cursor that will be positioned by the CURSOR control knob. In the VOLTS measurement mode, the cursor selected to be positioned (active cursor) will be displayed as a dashed horizontal line.

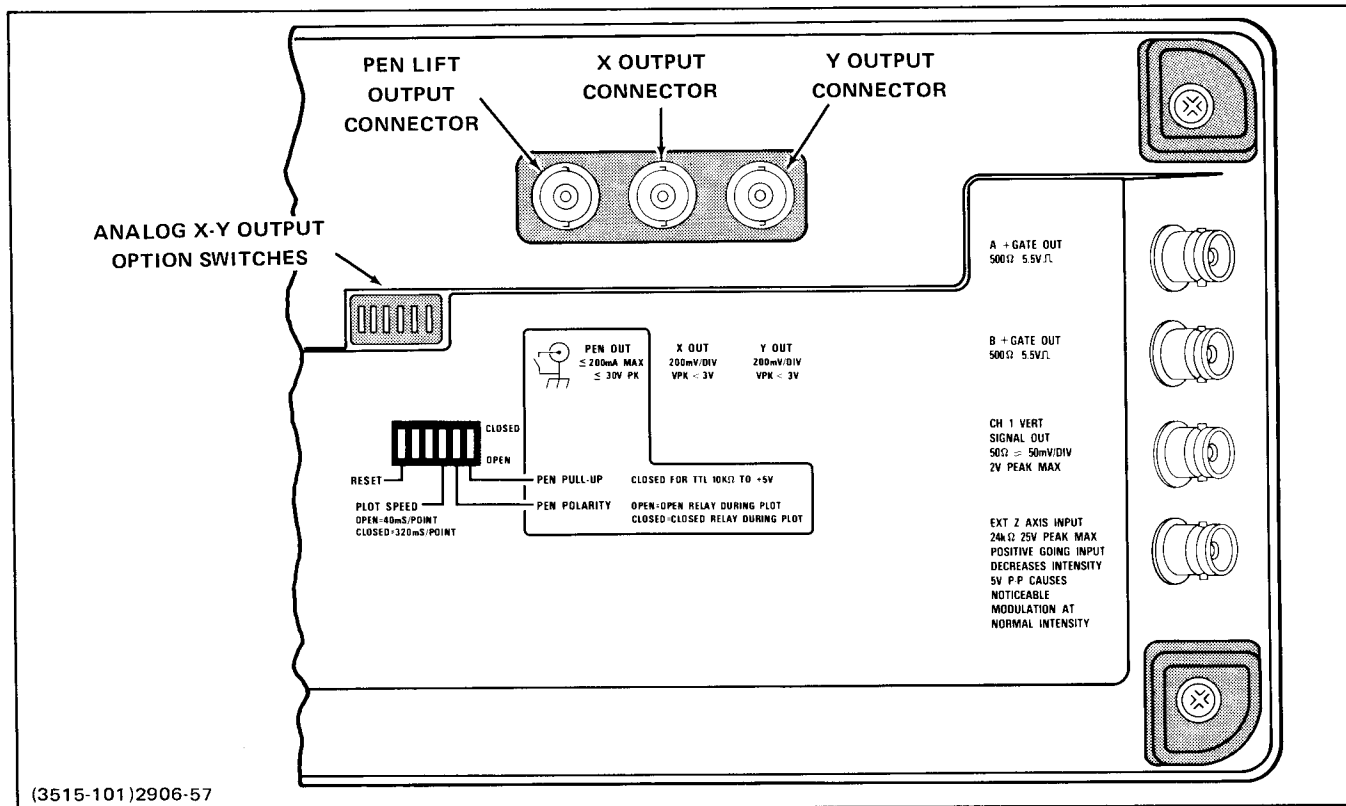

Figure 53. Location of Analog X-Y Output Option switches and output connectors.

Refer to Figure 9 for location of items 50 through 52.

- 50 NO. OF SWEEPS (AVG Option and ENVELOPE)**—When pressed in, the number of waveforms (sweeps) selected to be either averaged in the AVG Storage mode or accumulated in the ENVELOPE Storage mode is displayed on the seven-segment LED indicators. This number, for the AVG mode, may be changed in a binary sequence of 2, 4, 8, 16, 32, 64, 126, or 256 by rotating the CURSOR/NO. OF SWEEPS control knob to the end-stop positions. For ENVELOPE Storage mode, the number may also be set to acquire either one waveform or an unlimited number of waveforms (LED indication is 9999). If set for an unlimited number of waveforms, the digital storage circuitry will continually acquire data to be accumulated in the display until a new selection is made.

When the instrument is turned on, the number of sweeps or accumulators is automatically set to 32, and it will remain at this number until a different selection is made by the operator. Switching between any of the modes will not change the number selected for either ENVELOPE or AVG Storage mode.

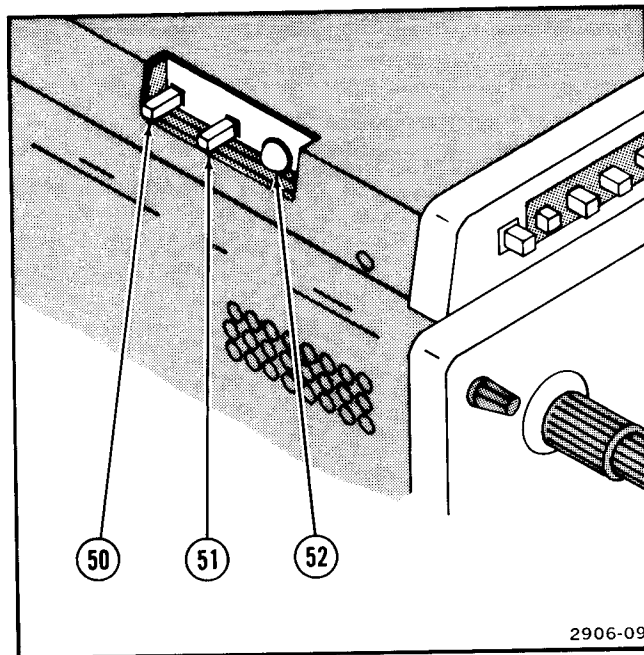

Figure 9. Digital storage left side panel controls and indicator.

NOTE

The RESET switch is maintenance only. If the switch is inadvertently closed while a waveform plot is occurring, the switch must remain closed until the remaining waveform data is dumped. Returning the switch to the OPEN position before the waveform data has finished dumping will cause a state control malfunction. If this should occur, cycle the POWER switch OFF; then ON again to clear the malfunction.

In addition to the external switch settings required, section 8 of the internal OPTIONS/SERVICE switch must be in the CLOSED position when power is applied to the instrument for the Analog X-Y Output Option to be enabled. If the PLOT switch is inoperable, refer the instrument to a qualified service person to check the switch position.

Refer to Figure 53 for the location of the Analog X-Y Output switches and the PEN OUT, X OUT, and Y OUT BNC connectors.

After the Analog X-Y Output switches are set for the X-Y Plotter to be used, no further setting of the switches is required. Connect the X OUT, Y OUT, and PEN OUT connectors to the X-Y Plotter, and set up the X-Y Plotter by following the operating instructions of the plotter in use.

Using the Option

Acquire a storage mode waveform to be plotted as per the operating instructions given both in this manual and in the 468 Service manual, then press in the PLOT push button (see Figure 54). The 468 will go into the SAVE Storage Mode, and the stored waveform will be plotted. If you wish to do more than one plot of the same waveform, press in the SAVE Storage Mode push button either prior to pressing in the PLOT push button or during the time the waveform is being plotted. The waveform will be saved for as long as the SAVE Storage Mode remains selected. At the completion of the plot, the 468 will return to the operating mode selected by the front-panel controls. If SAVE Storage Mode has not been selected, new waveform data will be acquired.

51 TRANSMIT (GPIB Option)—A momentary contact push-button switch that, when pressed, causes the 468 to go into the SAVE Storage mode to freeze the waveform at the end of the storage cycle in progress. The current contents of the digital storage memory are transmitted to the GPIB (General Purpose Interface Bus). During transmission time, cursor functions may be used, but controls that can affect the stored data will not be effective until completion of the data transmission. The oscilloscope will return to the selected operation mode upon completion of the transmission.

NOTE

The waveform data will be transmitted as acquired (no interpolation or expansion) with the exception of the AVG waveform acquired in the 0.5, 1, and 2 mV per division positions of the VOLTS/DIV switch. The AVG data is processed to produce added resolution in these VOLTS/DIV settings, and the processed AVG waveform is sent.

NOTE

For instruments with Option 02 (GPIB), a firmware bug exists in both version 1.0 and version 2.0 ROM. This causes an incorrect transmission of the Y-multiplier and the Y-units of a waveform whenever the acquired waveform is vertically uncalibrated or when an ADD display is obtained with unequal VOLTS/DIV switch settings. To avoid this bug, rotate the VAR VOLTS/DIV controls into the detent position and use the same VOLTS/DIV switch setting on both channels for ADD displays when acquiring the data for transmission.

Two ways of entering the TRANSMIT mode are possible as determined by the position (on or off) of the TALK ONLY switch on the 468 rear panel. When the TALK ONLY switch is on, the 468 is always a talker, and the waveform will be transmitted when the TRANSMIT button is pressed if the bus is active.

If the TALK ONLY switch is off, pressing the TRANSMIT button will cause the 468 GPIB option to transmit a service request (SRQ). The bus controller does a serial poll in response to the SRQ, and the 468 status byte indicates that a waveform is available. At the end of the poll, the controller arranges for listeners, if required, then sends the 468 talk address (MTA). Upon receiving MTA, the 468 GPIB interface transmits the waveform to the listener(s) on the bus. If device clear

OPTION 11 OPERATING INFORMATION

Introduction

This Option enables the 468 to convert the digital data stored in the storage display memory into analog X and Y outputs for driving an external X-Y Plotter. The analog outputs will conform to most currently produced X-Y Plotters. Electrical specifications for Option 11 are given in Table 11. All other specifications given in this manual remain unchanged.

Setting Up the Option

Operation of the Analog X-Y Output Option is largely automatic. Only a few switch settings are required before pressing the PLOT switch to start the operation. Refer to the Operators information of the X-Y Plotter in use for set-up and operation procedures required for using it. Information required for the correct setup of the Analog X-Y Output Option switches on the 468 rear panel should also be obtained from the instructions for the X-Y Plotter in use.

The required switch settings of the Analog X-Y Output switches shown in Figure 53 are as follows:

1. The PLOT SPEED switch must be set to match the X-Y Plotter characteristics. Choices of plot speed are 40 ms per data point (fast plot) and 320 ms per data point (slow plot).
2. The PEN POLARITY switch must be set to match the X-Y Plotter pen-lift signal requirements. When the switch is OPEN, the pen control relay will be open when the plotting pen should be down on the paper. When the switch is CLOSED, the pen control relay will be closed when the plotting pen should be down on the paper.
3. The PEN PULL-UP switch must be set to provide the proper level pen-lift signal for the plotter pen. The pen-lift voltage may be set either for no pull-up to the +5-V supply or for pull-up through a 10-k Ω resistor. The pen-lift voltage is pulled up when the switch is CLOSED and not pulled up when the switch is OPEN.
4. The RESET switch must be set to the OPEN (off) position for normal operation.

(DCL) is received by the 468 during transmission of a waveform, the GPIB interface will go to a state equivalent to having completed the transmission.

The data presented to the GPIB will conform to the Waveform Transmission Standard as specified by Tektronix Interface Standard—General Purpose Interface Bus (GPIB), Codes and Formats.

NOTE

Pressing the TRANSMIT button with no controller or listener on the bus will put the 468 into SAVE, and it will not return to normal operation. The only way to exit this condition is by cycling the POWER switch off, then on again.

The TRANSMIT switch circuit action can be disabled when the 468 is not connected to a GPIB system. Once disabled, it must be enabled before connecting the 468 to a GPIB system. Refer to qualified service personnel to have the GPIB option TRANSMIT switch circuit action either disabled or enabled.

52 GPIB Status Indicator (TIDS/SRQ) (Option)—A dual red/green LED indicator that illuminates to indicate GPIBstatus.

Red—Indicates that a service request (SRQ) has been issued by the 468. Power-on self-test will issue an SRQ, and the red LED will remain on if there is no device on the GPIB to respond to the SRQ.

GREEN—Indicates that the GPIB interface has been addressed to talk ($\overline{\text{TIDS}}$), either by a bus controller or by setting the TALK ONLY switch on and pressing the TRANSMIT push button.

In normal operation (with controller on the bus) the red LED will flash on (SRQ issued) when the TRANSMIT push button is pressed, and the green LED will be on ($\overline{\text{TIDS}}$, addressed to talk) during the actual transmission of data.

REAR PANEL

Refer to Figure 10 for location of items 53 through 58.

53 A +GATE OUT—Bnc connector providing an approximately 5 V, positive-going square wave coincident with the A Sweep time.

In the four-field PAL sequence with Bruch Sequence Color-Burst blanking, the fields are identified as follows:

Field 1: Field that follows a field ending in one-half line of video, when the preceding field has color burst on the last full line. Field 1 lines are 1 through 312 and half of line 313. Color burst starts on line 7 of Field 1; one-half line of video appears on line 23.

Field 2: Field that follows a field ending in a full line of video which does not carry color burst. Field 2 lines are the last half of line 313 through line 625. Color burst starts on line 319 (one line without burst following the last equalizing pulse); a full line of video appears on line 336.

Field 3: Field that follows a field ending in a half line of video when preceding field has no color burst on the last full line. Field 3 lines are through the first half of

the line 313. Burst starts on line 6 (immediately following the last equalizing pulse); one-half line of video appears on line 23.

Field 4: Field that follows a field ending in a full line of video carrying color burst. Field 4 lines are the second half of line 313 through line 625. Color burst for Field 4 starts on line 320 (two full lines without burst follow the last equalizing pulse); video starts with a full line on line 336.

NOTE

The FIELD 1 position of the A TRIGGER SLOPE switch selects NTSC or PAL Field 1 or 3 to start the display; the FIELD 2 position selects NTSC or PAL Field 2 or 4.

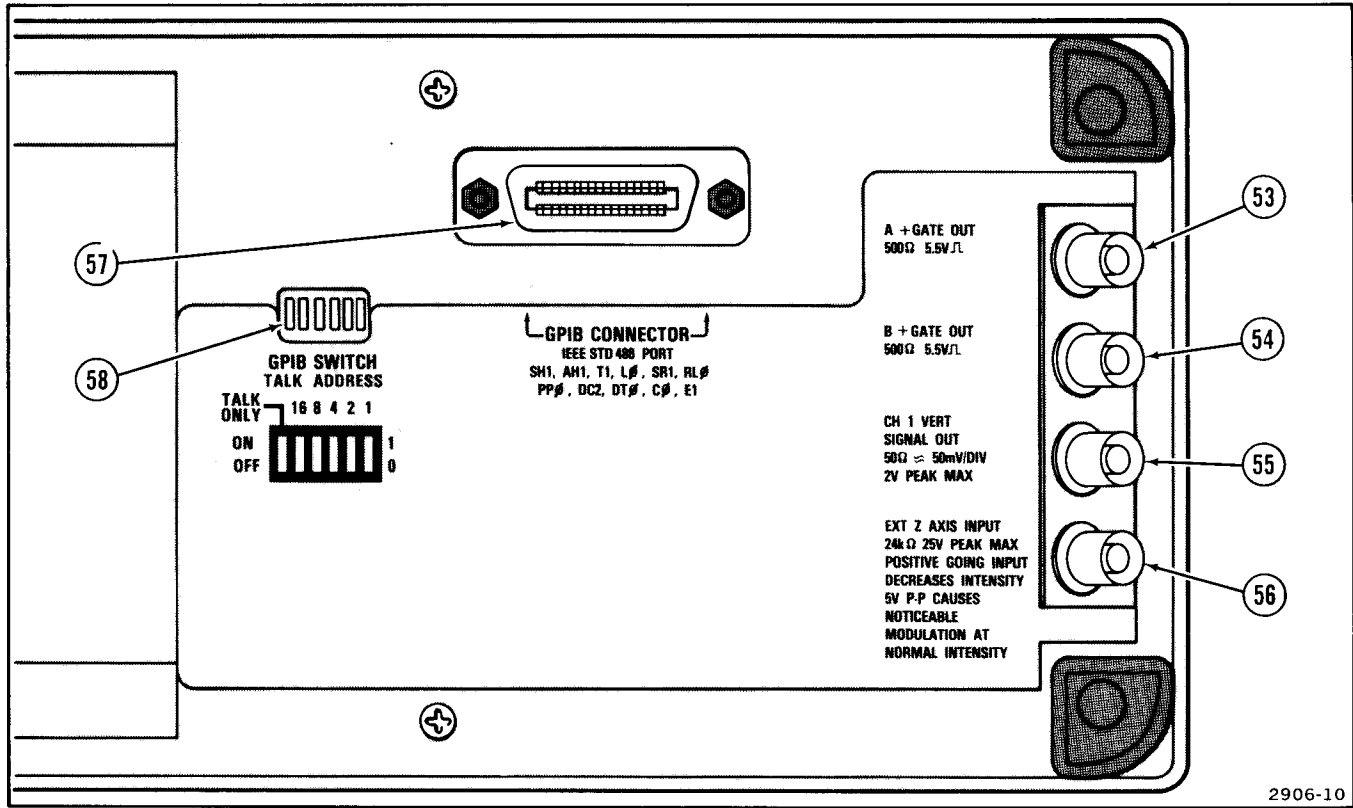

Figure 10. Rear panel controls and connectors.

Identifying Fields, Frames, and Lines in 525/60 and 625/50 TV Systems

NTSC (CCIR System M). Field 1 is defined as the field whose first equalizing pulse is one full H interval (63.5 μ s) from the preceding horizontal-sync pulse. The Field 1 picture starts with a full line of video, and lines are numbered 1 through 263, starting with the leading edge of the first equalizing pulse. The first regular horizontal-sync pulse after the second equalizing interval is the start of line 10.

Field 2 starts with an equalizing pulse a half-line interval from the preceding horizontal-sync pulse. The Field 2 picture starts with a half line of video, and lines are numbered 1 through 262, starting with the leading edge of the second equalizing pulse. After the second equalizing interval, the first full line is line 9.

In the M/NTSC four-field color system, Fields 3 and 4 are defined identically to Fields 1 and 2 respectively, except for the phase of the color reference subcarrier. In Fields 1 and 4, positive-going zero crossovers of the reference subcarrier nominally coincide with the leading edge of even-numbered horizontal sync pulses. In Fields 2 and 3, negative-going zero crossovers of the reference subcarrier nominally coincide with the leading edge of even-numbered horizontal sync pulses.

CCIR System B and Similar 625/50 Systems. Except for PAL systems, identification of parts of the picture in most 625-line, 50 Hz field-rate systems relies primarily on continuous line numbering rather than on field-and-line identification.

The CCIR frame starts with the first (wide) vertical-sync pulse following a field which ends with one-half line of video. The first line after the second equalizing interval is line 6; the first picture line is line 23 (one-half line of video). The first field of the frame contains lines 1 through the first half of line 313; the picture ends with a full line of video (line 310).

The second field of the frame commences with the leading edge of the first (wide) vertical sync pulse (in the middle of line 313) and runs through line 625 (end of the equalizing interval). The first full line after the equalizing interval is line 318; the picture starts on line 336 (full line of video).

The first field is referred to as "odd," and the second field is referred to as "even." Note that while the identification systems for System M and System B are reversed, the correct field sync (Field 1 or Field 2) as indicated by the A TRIGGER SLOPE switch setting is selected.

- 54 **B + GATE OUT**—Bnc connector providing an approximately 5 V, positive-going square wave coincident with the B Sweep time.
- 55 **CH 1 VERT OUT SIGNAL OUT**—Bnc connector providing an output signal with an amplitude of approximately 50 mV per each division of displayed Channel 1 signal into 1 M Ω or 25 mV per each division of displayed Channel 1 signal into 50 Ω .
- 56 **EXT Z-AXIS INPUT**—Bnc connector used to apply external signals to the Z-axis Amplifier to intensity modulate the crt display. Intensity modulation does not affect the displayed waveshape. Signals with fast rise and fall time provide the most abrupt intensity change. Positive-going signals decrease the intensity, and a 5 V peak-to-peak signal will produce noticeable modulation, Z-axis signals must be time related to the display to obtain a stable intensity modulation pattern on the crt. External Z-axis modulation is useful for the NON STORE mode only.
- 57 **GPIB Connector (Option)**—Standard GPIB connector allows interconnection with other devices on a GPIB. Conforms to IEEE-488 Standard of 1978.
- 58 **GPIB Switch (Option)**—The first section of this six-section, two-position switch controls the TALK ONLY local message. In the ON position, the 468 is permanently addressed as a talker. In the OFF position, the 468 must be addressed to talk by a bus controller. The remaining five sections of the switch set the binary talk address of the 468.
- Refer to Figure 11 for location of items 59 through 64.
- 59 **Line Fuse Holder**—Contains the line fuse. See Table 1 for fuse change information.
- 60 **Detachable Line Cord**—Makes the connection between the oscilloscope and the power source. The cord may be conveniently stored by wrapping it around the feet on the rear panel.
- 61 **Power Cord Jack**—Receptacle for detachable line cord.
- 62 **Mod Slots**—A number in either slot indicates the instrument contains an option or other modification.

Two-Frame Cycle. If PAL burst blanking is to be checked, set the A Sweep time for a 3 1/2-field cycle (5 ms/division, with the A TRIGGER HOLDOFF control set to about the four o'clock position). Then, use the B Sweep (ALT HORIZ DISPLAY is recommended) to identify fields and lines. At 5 ms/division, only slightly more than two fields will be displayed, while the trigger holdoff interval covers a full field. Putting a specific field on screen in a particular location will typically require several operations of the A TRIGGER SLOPE switch (switching back and forth between FIELD 1 and FIELD 2) to select the proper frame cycle.

Special Measurements

Overscanned Displays. For various video measurements it may be desirable to expand the video waveform vertically beyond the limits of the screen. Under these circumstances either the trigger amplifiers or Sync Separator may be overloaded, blocking out some sync pulses in the vicinity of strong video transitions, or losing sync pulses altogether. To avoid overload problems, use either an external sync signal or the other vertical channel to supply a constant-amplitude signal to the Sync Separator while overscanned observations are being made. Note, however, that transient-response aberrations in the main vertical amplifier will be increased when the signal is driven offscreen, and the aberrations will become relatively serious if the amplifier is driven to saturation and cutoff.

Horizontal-Sync Pulse Measurements. Measurements of the rise and fall times and the width of horizontal sync pulses typically do not require use of the Sync Separator, except when only certain lines or groups of lines appear abnormal. A bright display of all horizontal sync pulses is obtained when the A Sweep is triggered on the appropriate slope using LF REJ coupling and an A Sweep TIME/DIV switch setting of 5 μ s or less. Triggering stability may be upset by sharp luminance transitions at the right side of the picture, but a careful setting of the LEVEL control will typically permit accurate measurements. Use of the 5 μ s/division basic rate locks out most of the video (for 525- or 625-line systems) from triggering the A Sweep. When faster sweeps are needed, the A TRIGGER HOLDOFF control may be adjusted to block out video information.

RF Interference. Operation in the vicinity of some FM and TV transmitters may cause objectionable amounts of rf signal energy in the display, even when coaxial cables are used to make signal connections to the instrument. The front-panel 20 MHz BW LIMIT switch will usually eliminate such interference from the display, but it will not affect the signal applied to the Sync Separator. Where rf energy interferes with Sync Separator operation, external filters will be required. Use of probes designed for 10- to 30-MHz bandwidth oscilloscopes will provide 6- to 10-dB attenuation in the 50- to 100-MHz range and may be beneficial in reducing rf interference.

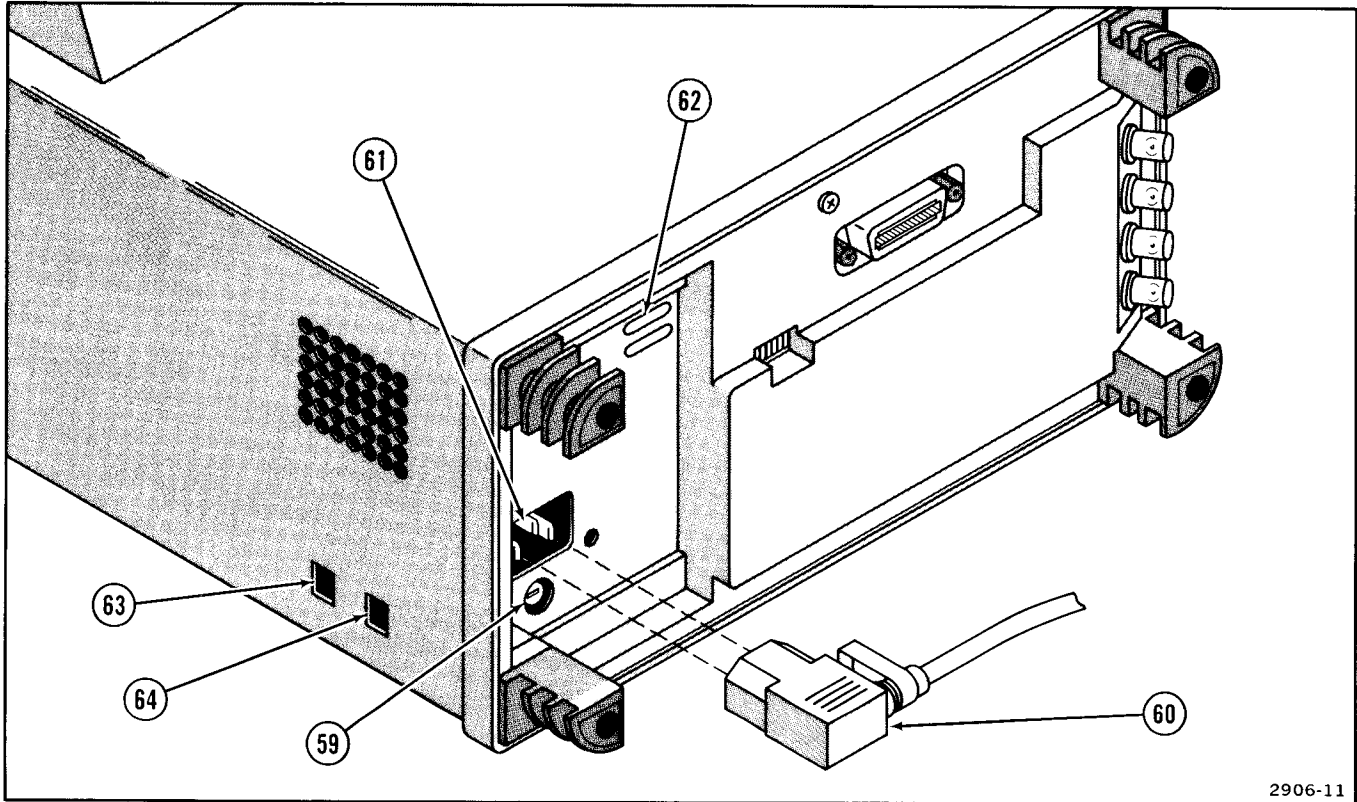

2906-11

Figure 11. Rear panel and right side panel power controls, connectors, and indicators.

All detailed measurements are then made using the B Sweep (HORIZ DISPLAY switches set either to B DLY'D or ALT) with the B TRIGGER SOURCE switch set either to STARTS AFTER DELAY (continuously variable B Sweep start point) or to TV LINE (B Sweep starts after the next horizontal sync pulse following the delay interval set by the DELAY TIME POSITION control and the A TIME/DIV switch setting).

Because the leading edge of the sync pulse will not be displayed, the typical B TIME/DIV switch setting for width measurement (front porch, back porch and horizontal-blanking intervals, horizontal sync, serration, and equalizing pulses) is 10 μ s/division. This setting will allow display of two consecutive pulses. Use the X10 MAG switch to display the second pulse at 1 μ s/division sweep rate.

For rise-and fall-time measurements on blanking and sync waveforms, trigger the A or B Sweep directly from the displayed waveform (avoiding the processing delay of the Sync Separator). This permits viewing the trigger edge at sweep rates from 0.5 μ s/division to 0.02 μ s/division.

Selecting an Individual Line

NOTE

For field and line identification systems, refer to "Identifying Fields, Frames, and Lines in 525/60 and 625/50 TV Systems" at the end of these Operating Instructions.

One-Frame Cycle. To display an entire vertical blanking interval for locating a specific line (e.g., one of the lines containing a specific VIT waveform), set the A TIME/DIV switch to 2 ms/division and the B TIME/DIV switch (pull to unlock from A) to 10 μ s/division. Ensure that the A TRIGGER HOLDOFF control is set to NORM (fully counterclockwise) and the A TRIGGER COUPLING switch is set to TV FIELD. Then, select the desired field (FIELD 1 or FIELD 2) with the A TRIGGER SLOPE switch.

Press in the A INTEN push button and use the DELAY TIME POSITION control to position the intensified zone (B Sweep) on the desired line. Pressing the B DLY'D button will then display the desired line on the B trace. Set HORIZ DISPLAY to ALT to view the A INTEN trace and B DLY'D trace simultaneously.

RIGHT SIDE PANEL

- ⑥③ **Regulating Range Selector Switch**—Selects the regulating range of the 468 power supplies to match the available ac-power-source voltage. See Table 2 for switch change information.

- ⑥④ **Line Voltage Selector Switch**—Selects either 115 V or 230 V nominal ac-power-source voltage. Refer to Table 2 for switch change information. The line fuse must be changed to match the ac-power-source voltage range selected (see Table 1).

LEFT SIDE PANEL

Refer to Figure 12 for location of items 65 and 66 (upper set of holes is CH 1, Lower set is CH 2).

- ⑥⑤ **Variable Balance Controls (accessible through left side panel)**—Screwdriver adjustments to set balance of each vertical channel.

- ⑥⑥ **Vertical Gain Controls (accessible through left side panel)**—Screwdriver adjustments to set the gain of each vertical channel.

GND-DC input coupling switch for the channel is not set to GND, the input amplifier and trigger channel are active, regardless of the selection of VERT MODE push buttons.

ADD Mode. A single-channel trigger signal amplitude is not affected by contribution of the other channel to an ADD vertical mode display. When the ADD mode, with Channel 2 inverted, is used to compare two video waveforms by subtraction, the Channel 1 or Channel 2 signal to the Sync Separator will be adequate for stable triggering, providing the individual channel signal meets the triggering requirements (including correct polarity).

When the ADD mode is used to display the full signal from both sides of a balanced line, it may be necessary to use the NORM (composite vertical signal) A TRIGGER COURSE switch position (if neither side of the line has sufficient amplitude for suitable triggering or if common-mode signals interfere with stable sync-separation and triggering).

Typical Operation

NOTE

The following procedures for selecting individual lines, fields, or frames are applicable to the operation of the 468 as a conventional (nonstorage mode) oscilloscope only. Due to the signal processing time required by the digital microprocessor when storing a waveform, the holdoff time between sweeps is increased in all storage modes. Therefore, the A TRIGGER HOLDOFF control has reduced action over the holdoff timing, except near its maximum clockwise rotation.

In a typical operating mode for the Option 05 instrument, the A Sweep establishes the basic frame and field presentation, and the B Sweep allows detailed observation and measurement of various portions of the video waveform.

For 50- and 60-Hz field rates, the 2 ms/division setting of the A TIME/DIV switch is usually selected. For some PAL system observations, a setting of 5 ms/division (approximately a 2 1/2-field display), with the A TRIGGER HOLDOFF control set to approximately the four-o'clock position (additional one-field holdoff), may be desirable to maintain a stable display relationship to the four-field PAL burst-blanking sequence.

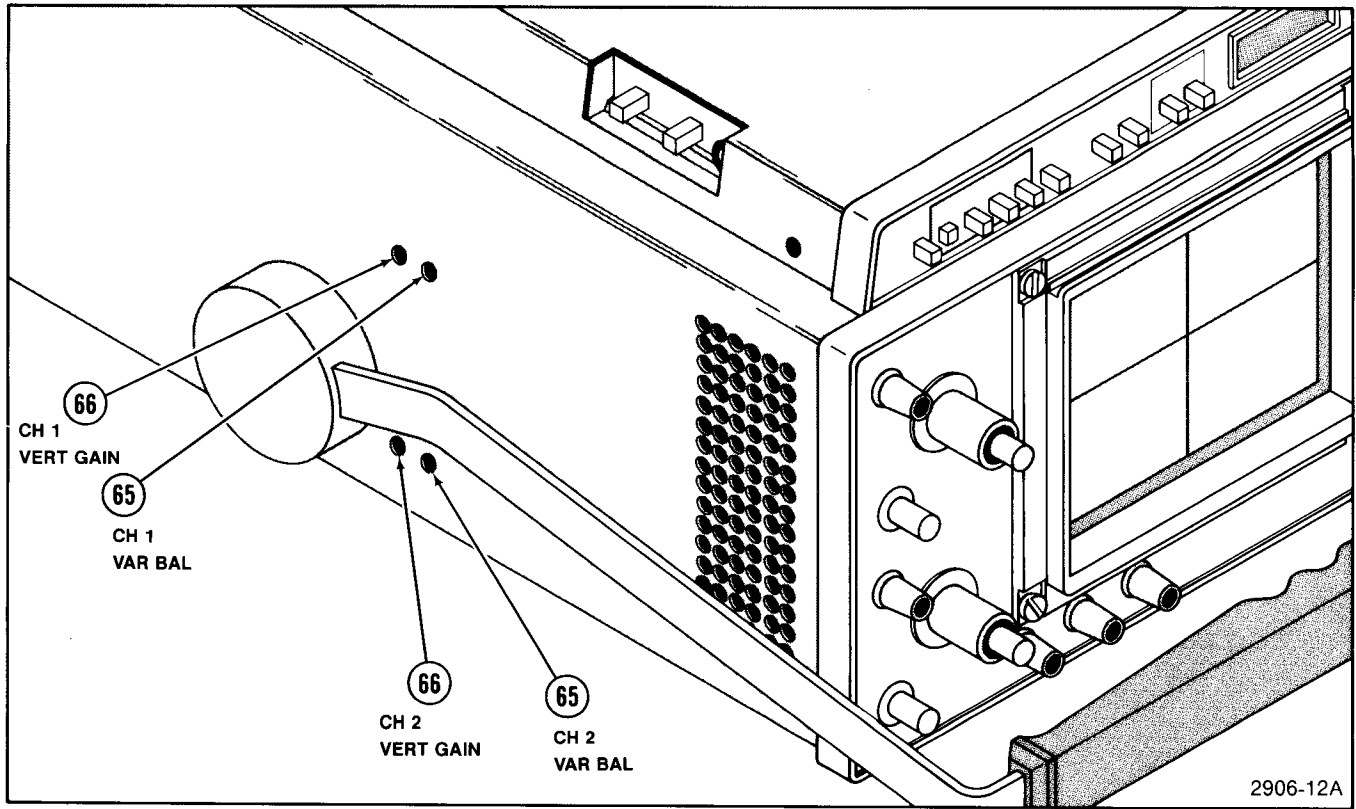

2906-12A

Figure 12. Left side panel controls.

used, selecting either Field 1 or Field 2 sync is accomplished by setting the A TRIGGER SLOPE switch to the desired field. In the PAL four-field TV system, the FIELD 1 position selects either Field 1 or Field 3, and the FIELD 2 position selects either Field 2 or Field 4. Refer to "Identifying Fields, Frames, and Lines in 525/60 and 625/50 TV Systems" to identify the specific field being viewed.

To trigger the B Sweep from the line-rate trigger output of the Sync Separator, perform the following steps:

1. Set the A TRIGGER COUPLING SWITCH TO EITHER TV FIELD or TV LINE and ensure that the A Sweep is running.

NOTE

The B Sweep cannot be operated independently of the A Sweep and cannot run more than once for each A Sweep cycle. For composite line displays, refer to "Special Measurements" in this section.

2. Set the B TRIGGER SOURCE switch to TV LINE.

3. Adjust the B TRIGGER LEVEL control for a stable, triggered sweep.

Vertical Operating Modes—Special Considerations

Dual-Trace Modes. For dual-trace operation, the Sync Separator input must be taken from CH 1, CH 2, or an external source. (When only one trace is displayed on the crt, the NORM position of the A TRIGGER SOURCE switch may be used.) The Sync Separator cannot correctly process switched (composite vertical deflection) waveforms present on the NORM trigger signal line in either the ALT or CHOP dual-trace vertical mode; it is therefore not possible to obtain stable simultaneous displays of two independent video signals that are not time related.

Single-Channel Triggering. When triggering from Channel 1 or Channel 2, the waveform fed to the Sync Separator is the same (except for positioning) as that displayed on the crt when the channel is selected to display a signal. If the VOLTS/DIV VAR control is used to reduce displayed amplitude, then the signal to the Sync Separator is also reduced. When the Channel 2 INVERT switch is pressed in, the CH 2 signal to the A TRIGGER SOURCE switch is also inverted. Since the Sync Separator requires sync-negative waveforms for proper operation, it will be necessary to observe correct signal polarity when selecting the A TRIGGER SOURCE signal.

It is not necessary to display the Channel 1 or Channel 2 signal to obtain CH 1 or CH 2 triggering. Whenever the AC-

OPERATING CONSIDERATIONS

GRATICULE

The graticule is internally marked on the face of the crt to enable accurate measurements without parallax error. The graticule is marked with eight vertical and ten horizontal major divisions. In addition, each major division is divided into five minor divisions. Vertical deflection factors and horizontal timing, as well as the storage mode VOLTS and TIME cursors, are calibrated to the graticule so that measurements of amplitude and time duration may be made directly on the displayed waveform.

GROUNDING

The most reliable signal measurements are made when the 468 and the unit under test are connected together by a common grounding lead in addition to the signal lead or probe. The ground lead on the probe provides the best ground method for signal interconnection and ensures the maximum amount of shielding of the signal lead in the probe cable. A separate ground lead from the unit under test may be connected to the oscilloscope chassis ground banana jack located on the lower left portion of the instrument front panel.

SIGNAL CONNECTIONS

Probes

Generally, probes offer the most convenient means of connecting an input signal to the instrument. They are shielded to prevent pickup of electromagnetic interference, and the supplied 10X probe offers a high input impedance that minimizes circuit loading. This allows the circuit under test to operate with a minimum of change from the normal condition of the circuit when measurements are being made. Signal amplitude is attenuated by a factor of 10 by the probe, and the scale-factor LED (located behind the skirt of the VOLTS/DIV knob on each channel) is switched to indicate the correct scale factor. The digital storage VOLTS measurement scale factor will be automatically set when the channel scale factor is switched.

Coaxial Cables

Cables also may be used to connect signals to the input connectors, but they may have considerable effect on the accuracy of the displayed waveform. To maintain the original frequency characteristics of an applied signal, use only low-loss, high-quality coaxial cable. Also, cables should be

Operation of the Sync Separator

To trigger the 468 on a video signal, perform the following steps:

1. Set the A TRIGGER COUPLING switch to either TV FIELD or TV LINE.

2. Determine the polarity of the composite video or composite sync waveform applied to the 468. The Sync Separator requires normal (sync-negative) video with sync at the negative peak. To obtain proper Sync Separator operation from inverted (sync-positive) video (sync at the positive peaks and peak video at the negative peaks), apply the signal to the CH 2 input connector, select CH 2 as the A TRIGGER SOURCE, and use the CH 2 INVERT feature to obtain the proper signal polarity.

NOTE

Composite Sync is the vertical and horizontal sync signals combined in a single waveform, but without video (picture) information. Composite Video is the picture waveform complete with vertical and horizontal blanking and sync components.

3. Use the A TRIGGER SLOPE switch to select the desired field for use as the trigger signal, if the A TRIGGER SOURCE switch is set to the TV FIELD position.

For special considerations in dual-trace modes (ALT or CHOP), refer to "Vertical Operating Modes—Special considerations" in this section. For internal triggering, the sync portion of the displayed waveform should be at least 0.5 cm high (7 units on the CCIR graticule scale or 10 units on the NTSC graticule scale). For external triggering, the sync portion of the waveform should be at least 50 mV in amplitude (or 0.50 V with the SOURCE switch set to EXT/10). To avoid circuit overload and partial or complete loss of sync, do not exceed the specified maximum composite video amplitude (15 div for internal triggering; 1.5 V for external triggering).

Triggering the Sweep

The output of the Sync Separator is fed via the A TRIGGER COUPLING switch to the A Sweep Trigger circuit and via the B TRIGGER SOURCE switch to the B Sweep Trigger circuit. Triggering the A Sweep from the TV FIELD or TV LINE sync signal requires only the proper setting of the A TRIGGER LEVEL control. When TV FIELD rate triggering is

terminated at both ends in the characteristic impedance. If this is not possible, use suitable impedance-matching devices.

INPUT COUPLING CAPACITOR PRECHARGING

In the GND position of the Input Coupling switch, the input signal is connected to ground through the coupling capacitor and a high resistance to form a precharging network for the coupling capacitor. This network allows the input coupling capacitor to charge to the average dc-voltage level of the signal applied to the probe. Thus, large voltage transients are not generated that could be applied to the amplifier input when the input coupling is switched from GND to AC. The precharging network also provides a measure of protection to the external circuitry by reducing the current levels that can be drawn from the external circuitry during coupling capacitor charging.

If AC input coupling is used, the following procedure should be followed whenever the probe tip is connected to a signal source having a different dc level than that previously applied. This procedure becomes especially useful if the dc level difference is more than 10 times the VOLTS/DIV switch setting.

1. Set the AC-GND-DC switch to GND before connecting the probe-tip to a signal source.
2. Touch the probe tip to the oscilloscope chassis ground.
3. Wait several seconds for the input coupling capacitor to discharge.
4. Connect the probe tip to the signal source.
5. Wait several seconds for the input coupling capacitor to charge.
6. Set the AC-GND-DC switch to AC. A signal with a large dc component can be vertically positioned within the graticule area, and the ac component of the signal can be measured in the normal manner.

INSTRUMENT COOLING

To maintain adequate instrument cooling, the ventilation holes in the equipment cabinet must remain open, and the air filter must be clean. The air filter should be visually checked every few weeks and cleaned or replaced if dirty. More frequent inspections are required under severe operating conditions.

Furnished Accessories

The following accessories are provided with Option 05 instruments:

1. Graticule, NTSC (CCIR System M): -40 to +100 units, with 7.5-unit setup line; horizontal divisions along line zero (for part number see "Option 05 Accessories" at the back of this manual).

2. Graticule, CCIR (CCIR System B): zero to +100 units, 35-unit setup line; horizontal divisions along line 30 (for part number see "Option 05 Accessories" at the back of this manual).

Installation of the Video Graticule

1. Loosen the four captive bezel securing screws about six turns and remove the bezel.

2. Remove the implosion shield from the two bosses on the bezel and install the desired graticule ensuring that the markings are on the surface away from the crt face. The graticule can be positioned horizontally a small amount to align the external graticule and mask with the internal crt graticule lines.

NOTE

The extended tab at the bottom of the video graticule mates with the slightly wider bottom margin of the graticule cover.

3. Position the bezel in place and secure it with the four captive screws.

Vertical Calibration for CCIR and NTSC Video Graticules

When the video graticule is installed, the 10 horizontal divisions along line 0 correspond to the internal graticule divisions, and the TIME/DIV calibration of the oscilloscope remains unchanged. However, the vertical divisions represent only proportions of the 100-unit (CCIR) or the 140-unit (NTSC) video waveform, and the vertical VOLTS/DIV calibration is inapplicable.

To calibrate for a standard 1 V (nominal) video signal, apply the 300 mV CALIBRATOR square-wave signal to either the CH 1 or CH 2 vertical input and adjust the associated VOLTS/DIV and VOLTS/DIV VAR controls so that the displayed waveform occupies either 30 units on the CCIR graticule or 42 units on the NTSC graticule. This adjustment may be made with a well-focused, free-running display.

OSCILLOSCOPE DISPLAYS

The procedures in this section will allow you to set up and operate your instrument to obtain the most commonly used oscilloscope displays. Before proceeding with these instructions, verify that both the Line Voltage Selector switch and the Regulating Range Selector switch are placed in the proper positions and that the correct line fuse is installed for the ac-power-input voltage being used. Refer to the "Preparation for Use" instructions in this manual for the information and procedures relating to ac-power-input-source voltage, regulating range, and fuse selection. Verify that the POWER switch is OFF (push button out), then plug the power cord into the ac-power-input source outlet.

NON STORE DISPLAYS

The following procedures are used to obtain the most commonly used conventional oscilloscope displays.

NORMAL SWEEP DISPLAY

1. Preset the instrument controls as follows:

Vertical			
VERT MODE	CH 1	VOLTS/DIV VAR	Calibrated detent
VOLTS/DIV	Proper setting determined by amplitude of signal to be applied	AC-GND-DC (Input Coupling)	AC
		POSITION	Midrange
		20 MH BW LIMIT	Not limited (push button out)
		INVERT	Off (push button out)
			Display
		INTENSITY	Fully counterclockwise
		FOCUS	Midrange
		SCALE ILLUMINATION	Midrange

Specification

Electrical characteristics and performance requirements listed in the “Specification” part of this manual are applicable to the 468 Option 05 oscilloscope with the following exceptions or additions.

Vertical Input^a

Resistance	1 MΩ within 2%
Capacitance	Approximately 24 pF
Time Constant	Approximately 24 μs

AC Input Coupling^a

Low Frequency –3 dB Point

Direct	1 Hz
Via 10X Passive Probe	0.1 Hz

Tilt (10-ms pulse)^a

Direct	2.5%
Via 10X Passive Probe	0.25%

Triggering^a

Sync Separation	Stable video rejection and sync separation from sync-negative composite video, 525- to 1201-line, 50- or 60-Hz field rate.
-----------------	--

Sync-positive composite video can be separated by applying the input signal to the CH 2 input connector and using the CH 2 INVERT feature.

FIELD 1 and FIELD 2 trigger signals are selectable with the A TRIGGER SLOPE switch for interlaced field systems. A trigger signal is generated for every field in noninterlaced field systems.

Trigger Amplitude ^a		Min	Max
Internal	Composite Video (nominal) ^b	1.5 cm	15 cm
	Composite Sync	0.5 cm	20 cm
External	Composite Video (nominal)	150 mV	1.5 V
	Composite Sync	50 mV	2.0 V
EXT/10	Composite Video (nominal)	1.5 V	15 V
	Composite Sync	500 mV	20 V

^a Performance requirement not checked in manual.

^b Peak video is approximately 7/3 sync amplitude.

Horizontal

TIME/DIV (A and B)	Locked together at 0.1 ms
A TIME/DIV VAR	Calibrated detent
HORIZ DISPLAY	A
X10 MAG	Off (Push button out)
POSITION	Midrange

TRIGGER (both A and B if applicable)

SLOPE	+ (plus)
LEVEL	0 (midrange)
SOURCE	NORM
COUPLING	AC
TRIG MODE (A only)	AUTO
A TRIG HOLDOFF	NORM (fully ccw)

Digital Storage

NON STORE	Push button in
-----------	----------------

2. Push the POWER push button in (ON) and allow the instrument time to warm up. Using the supplied 10X probe or a properly terminated coaxial cable, apply a signal to the CH 1 input connector. The signal source output impedance determines the termination required when using a coaxial cable to interconnect test equipment.

NOTE

Instrument warmup time required to meet all specification accuracies is 20 minutes.

3. Advance the INTENSITY control until the display is visible. If the display is not visible with the INTENSITY control at midrange, press the BEAM FIND push button and hold it in while adjusting the Channel 1 VOLTS/DIV switch to reduce the vertical display size. Center the compressed display using the Vertical and Horizontal POSITION controls. Release the BEAM FIND push button.

4. Set the Channel 1 VOLTS/DIV SWITCH AND THE Vertical and Horizontal POSITION controls to locate the display within the graticule area.

5. Adjust the A Trigger LEVEL control for a stable, triggered display.

6. Set the A TIME/DIV switch for the desired number of cycles of displayed signal. Then adjust the FOCUS control (and ASTIG, if necessary) for the best defined display.

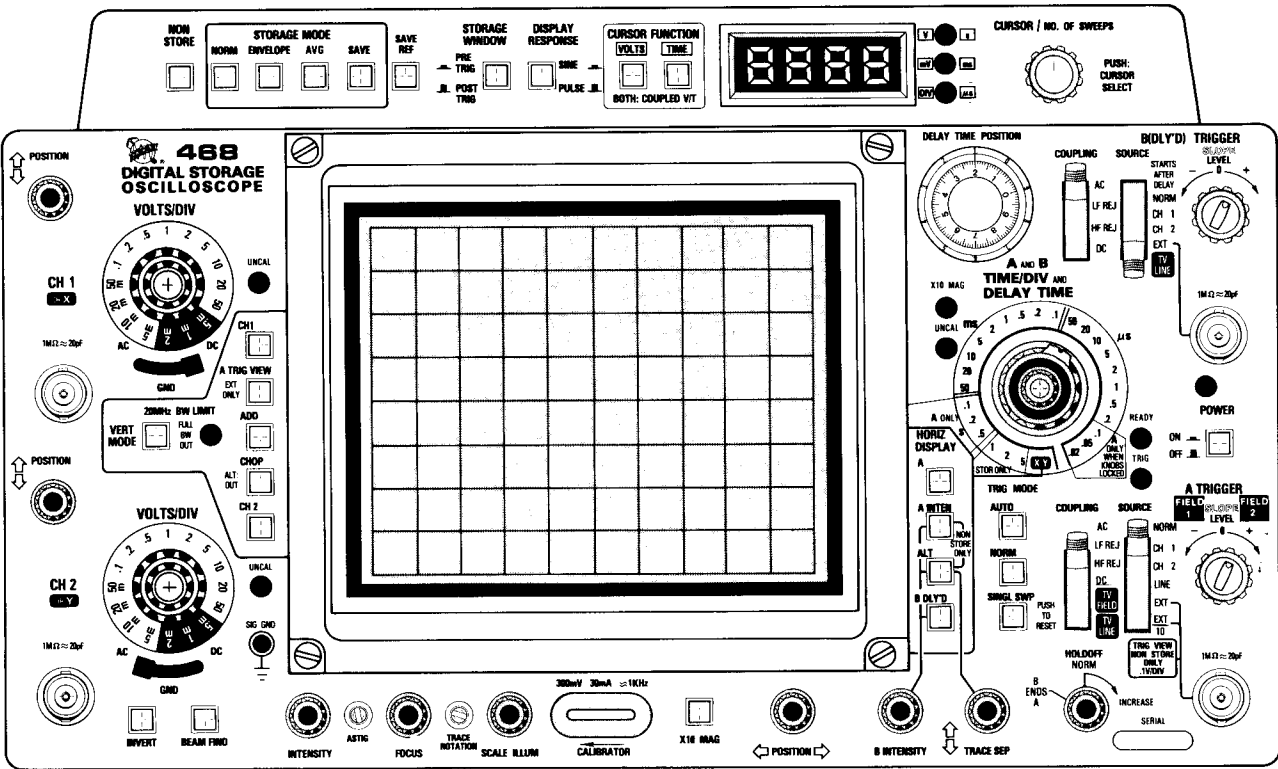

2906-55

Figure 52. The 468 Oscilloscope with Option 05.

MAGNIFIED SWEEP DISPLAY

1. Obtain a Normal Sweep Display.
2. Adjust the Horizontal POSITION control to move the area to be magnified to within the center crt graticule division (0.5 division on each side of the center vertical graticule line). Change the TIME/DIV switch setting as required.
3. Press the X10 MAG push-button switch in (on) and adjust the Horizontal POSITION control for precise positioning of the magnified display.
4. To calculate the magnified sweep rate, divide the TIME/DIV switch setting by 10.

B DELAYED SWEEP DISPLAY

1. Obtain a Normal Sweep Display.
2. Set the HORIZ DISPLAY switch to A INTEN and the B Trigger SOURCE switch to STARTS AFTER DELAY.

3. Pull out the B TIME/DIV knob to unlock it from the A TIME/DIV knob and turn it clockwise from the counterclockwise stop until the intensified zone is the desired length. Adjust the INTENSITY and B INTENSITY controls as required to make the intensified zone distinguishable from the remainder of the display.

4. Adjust the DELAY TIME POSITION control to move the intensified zone to cover that portion of the A trace that is desired to be displayed on the B trace.

5. Set the HORIZ DISPLAY switch to B DLY'D. The intensified zone adjusted in steps 3 and 4 is now displayed as the B trace at the sweep rate indicated by the white stripe on the B TIME/DIV knob.

6. A more stable display with less jitter may be obtained by setting the B Trigger SOURCE switch to match the position of the A Trigger SOURCE switch and adjusting the B Trigger LEVEL control for a stable display.

OPTION 05-TV SYNC SEPARATOR

The information and instructions presented here apply to the use of the 468 Option 05 instrument in TV applications. Refer to the appropriate sections of the Operator's manual for use and operation of the instrument for non-TV applications.

General Information

Option 05 includes a TV Sync Separator and provides the instrument with front-panel selection of additional trigger-signal processing to facilitate observation and measurement of composite video and related television waveforms. Added circuitry provides amplification, clipping, and vertical sync recognition. Vertical (field rate) and horizontal (line rate) trigger signals are selected with the A TRIGGER COUPLING switch for A Sweep triggering. Horizontal (line rate) trigger signals may start the A Sweep on either Field 1 or Field 2 ("even" or "odd" fields respectively in CCIR System B terminology). Trigger signal selection is accomplished with the A TRIGGER SLOPE switch.

When the A TRIGGER COUPLING switch is set to either TV FIELD or TV LINE (see Figure 52), the A TRIGGER SOURCE switch selects the source of the signals to be processed in the Sync Separator. This includes NORM

(composite vertical signal), CH 1, CH 2, EXT, or EXT/10. (LINE source is not a usable function with TV FIELD or TV LINE coupling.)

With the A TRIGGER COUPLING switch set to either TV FIELD or TV LINE, the selected sync output from the Sync Separator is automatically applied to the A Sweep TRIGGER circuit for use as the triggering signal for the A Sweep. For the B Sweep, the horizontal-sync signal (line-rate sync) from the Sync Separator is fed only to the TV LINE position of the B TRIGGER SOURCE switch to be selected at the option of the user.

Option 05 circuitry requires sync-negative composite video for proper operation. This signal polarity is used with most standard broadcast systems employing 405 to 819 lines at 50- or 60-Hz field rates and with closed-circuit systems having up to 1201 lines at a 60-Hz field rate. Sync-positive video may be used as discussed later under "Operation of the Sync Separator."

To optimize video measurements, the vertical amplifier ac coupling input capacitors are increased from 0.019 μF to 0.2 μF . The larger physical size of these capacitors increases the input shunt capacitance to a normalized value of 24 pF.

NOTE

The DELAY TIME POSITION control will not provide continuously variable delay when the B Trigger SOURCE is set to a position other than STARTS AFTER DELAY. Also, differential time measurements are invalid when the B Trigger SOURCE switch is not set to STARTS AFTER DELAY.

ALTERNATE HORIZONTAL SWEEP DISPLAY

1. Obtain a Normal Sweep Display.
2. Set the HORIZ DISPLAY switch to ALT and the B Trigger SOURCE to STARTS AFTER DELAY.

NOTE

Two traces will be visible; the A trace with an intensified zone, and the B DLY'd trace.

3. Adjust the Channel 1 POSITION control and TRACE SET control as required to display the A trace above the B trace.

4. Pull out the B TIME/DIV knob to unlock it from the A TIME/DIV knob, and turn it clockwise to the desired B Sweep rate. (The B Sweep rate is indicated by the white stripe on the B TIME/DIV knob.)

5. Adjust the INTENSITY and B INTENSITY controls as required to make the intensified zone distinguishable on the A trace and to set the B trace intensity to the desired brightness.

6. Adjust the DELAY TIME POSITION control to move the intensified zone to cover the portion of the A trace that is to be displayed on the B trace.

X-Y DISPLAY

1. Obtain a Normal Sweep Display. Rotate the INTENSITY control fully counterclockwise and disconnect the CH 1 input signal.

2. Use equal length coaxial cables, or the two supplied 10X probes, and apply the vertical signal (Y-axis) to the CH 2 OR Y input connector and the horizontal signal (X-axis) to the CH 1 OR X input connector.

```
4006 REM: UNTALK AND UNLISTEN ALL DEVICES
4007 WBYTE @63.95:
4008 DIM C$(1)
4010 E=1
4015 REM: WAIT FOR OPERATOR TO ENTER A KEY
      BEFORE RETURNING
4020 INPUT C$
4025 PAGE
4030 RETURN
6000 REM:#####
6001 REM:
6002 REM: ROUTINE TO DRAW GRATICULE FOR
      WAVEFORM DISPLAY
6003 REM:
6004 REM:#####
6005 REM: DRAW GRATICULE IN LOWER RIGHT
      PORTION OF SCREEN
6010 VIEWPORT 20,120,11.2,91.2
```

```
6015 REM: SET LIMITS OF GRAPHICS
6020 WINDOW 0,511,101.4,920.6
6025 REM: POSITION CURSOR TO BEGIN DRAWING
      GRATICULE
6030 MOVE 0,101.4
6040 DRAW 511,101.4
6050 DRAW 511,920.6
6060 DRAW 0,920.6
6070 DRAW 0,101.4
6080 AXIS 10.24,20.48,255,511
6090 FOR I=1 TO 9
6100 AXIS 0,0,1*51.2,I*102.4+101.4
6110 NEXT I
6120 VIEWPORT 30,130,0,100
6130 WINDOW 0,511,0,1023
6140 HOME
6150 RETURN
```

3. Set the A TIME/DIV switch fully counterclockwise to the X-Y position.

NOTE

For instruments with firmware version 1.0, both the CH 1 and CH 2 VERT MODE push buttons must be pressed in to illuminate the scale-factor LED only. It is not necessary to select any VERT MODE to obtain the X-Y display.

4. Advance the INTENSITY control until the display is visible. If the display is not visible with the INTENSITY control at midrange, press and hold in the BEAM FIND push button while adjusting the Channel 1 and Channel 2 VOLTS/DIV switches until the display is reduced in size, both vertically and horizontally. Center the compressed display with the POSITION controls (Channel 2 POSITION control for vertical movement; Horizontal POSITION control for horizontal movement). Release the BEAM FIND PUSH BUTTON. Adjust the FOCUS control for a well-defined display.

NOTE

The display obtained when sinusoidal signals are applied to the X- and Y-axis is called a Lissajous Figure. This display is commonly used to compare the frequency and phase relationship of the two input signals. The frequency relationship of the two input signals determines the pattern seen. The pattern will

be stable only if a common divisor exists between the two frequencies.

5. Disconnect the input signals from the channel input connectors and rotate the A TIME/DIV knob to 1 ms per division.

SINGLE SWEEP DISPLAY

1. Obtain a Normal Sweep Display. For random signals, set the A Trigger LEVEL control to trigger the sweep on a signal that is approximately the same amplitude as the random signal.

2. Press the SINGL SWP push button. The next trigger pulse will initiate the sweep, and a single trace will be displayed. If no trigger signal is present, the READY indicator LED should illuminate to indicate that the A Sweep Generator circuit is set to initiate a sweep when a trigger signal is received.

3. When the single sweep has been triggered, and the sweep is completed, the sweep logic circuitry is locked out. Another sweep cannot be generated until the SINGL SWP push button is pressed to set the Sweep Generator to the READY condition.

```

1394 REM: RETURN CURSOR TO UPPER LEFT
      CORNER OF SCREEN
1395 HOME
1398 RETURN
2000 REM: THIS IS HERE IN CASE AN SRQ IS
      ASSERTED BEFORE THIS PROGRAM
2001 REM: IS STARTED RUNNING.
2005 DIM Q(10)
2010 GOSUB 1000
2015 H=1
2020 T=1
2025 GOSUB 3000
2030 GO TO 110
3000 REM:#####
3001 REM:
3002 REM: SRQ SERVICE ROUTINE
3003 REM:
3004 REM:#####
3005 REM:POLL DEVICES TO SEE WHICH
      INSTRUMENT REQUESTED SERVICE
3010 POLL D,S;A
3020 REM:ONLY 1 DEVICE ATTACHED, NO NEED
      TO CHECK DEVICE NUMBER (D)
3021 REM: ADJUST STATUS SO IT IS A NUMBER
      BETWEEN 1 AND 4
3022 REM: STATUSES: PON = 65, TRANSMIT
      REQUEST = 195, TON = 196
3025 IF S<64 THEN 3100
3030 S=S-64

```

```

3035 REM: NOW CHECK TO SEE IF IT IS TRANSMIT
      OR TON
3040 IF S<100 THEN 3060
3045 REM: IF TRANSMIT OR TON, MUST ADJUST
      AGAIN (SUBTRACT 128)
3050 S=S-128
3055 REM: NOW SET TASK TO BE PROCESSED (ADD
      TO TASK QUEUE)
3060 Q(T)=S
3065 T=T+1
3070 IF T<=10 THEN 3080
3075 T=1
3080 IF H=T THEN 3090
3085 RETURN
3090 REM: A QUEUE ERROR OCCURRED, QUEUE IS
      FULL.
3095 PRINT "QUEUE FULL—PROGRAM ABORTED"
3099 GO TO 8
3100 REM: ILLEGAL STATUS BYTE PICKED UP
3110 PRINT "ILLEGAL STATUS BYTE RECEIVED.
      STATUS=";S
3115 PRINT "ISSUING DEVICE CLEAR"
3120 GO TO 8
4000 REM:#####
4001 REM:
4002 REM: EOI ROUTINE
4003 REM:
4004 REM:#####
4005 REM: SET FLAG TO SAY EOI ENCOUNTERED

```

DIGITAL STORAGE DISPLAYS

The following procedures explain how to set up and use the digital storage capabilities of the 468. Front panel controls set the conditions under which a waveform is acquired for display. Display amplitude is controlled by the VOLTS/DIV switches, and the storage window is controlled by the A or B TIME/DIV switch. Certain conditions of Vertical Mode selection and Storage Mode selection will store waveforms under a priority plan. See Table 3 for a complete chart describing the waveform stored for both display and reference with different combinations of Vertical Mode and Storage Mode selections.

NORM STORAGE MODE DISPLAY

1. Obtain a Normal Sweep Display of the waveform to be stored.
2. If the signal is obtained at sweep speeds of $1 \mu\text{s}$ per division or faster, select either the SINE Display Response for sinusoidal signals or PULSE Display Response for pulse-type signals.
3. Select PRE TRIG or POST TRIG Storage Window. PRE TRIG will cause 7/8 of a waveform to be stored before the trigger event; POST TRIG will cause only 1/8 of a waveform to be stored before the trigger event. In both cases, the remaining portion of the waveform is stored after the trigger event occurs.
4. Press the NORM Storage Mode push button in.

```

1016 PRINT "#3: ASSIGNS INSTRUMENT AS
      TALKER (REQUESTS A WAVEFORM)"
1017 PRINT
1018 PRI "WHEN A WAVEFORM IS SENT THE
      FOLLOWING INFORMATION IS PRINTED"
1019 PRINT
1020 PRINT "VERSION NO. CHANNEL, COUPLING"
1021 PRINT "          XMULTIPLIER,
          TRIGGER POINT, X
          UNITS"
1022 PRINT "          YMULTIPLIER,
          GROUND POINT, Y
          UNITS"
1023 PRINT
1024 PRINT "AFTER ALL WAVEFORMS HAVE BEEN
      DRAWN, YOU MUST PRESS <CR>"
1025 PRINT "TO PAGE THE SCREEN AND GO BACK
      TO WAITING FOR THE NEXT"
1026 PRINT "GPIB REQUEST."
1027 PRINT
1028 PRINT "MAKE SURE THE GPIB CABLE IS CON-
      NECTED BEFORE SENDING A"
1029 PRINT "WAVEFORM OR REQUESTING ONE
      USING THE 4051."
1030 PRINT
1031 PRINT "THIS PROGRAM CAN BE
      AUTOLOADED IF IT IS FILE #1 ON TAPE."
1032 PRINT
1033 PRINT "PRESS <CR> TO CONTINUE"
1034 DIM I$(1)
1035 INPUT I$
1038 PAGE
1040 PRINT "ENTER GPIB ADDRESS OF 468
      (NUMBER BETWEEN 0 AND 30):";
1045 INPUT A
1045 IF A<0 THEN 1065
1055 IF A>30 THEN 1065
1060 RETURN
1065 PRINT "ADDRESS IS OUTSIDE 0-30 RANGE.
      RE-ENTER ADDRESS:";
1070 GO TO 1045
1350 REM: #####
1351 REM:
1352 REM: ROUTINE TO PLOT WAVEFORM
1353 REM:
1354 REM: #####
1355 VIEWPORT 20,122.4,0,102.4
1358 REM: CHECK NUMBER OF WAVEFORM BYTES
1360 IF B=256 THEN 1375
1363 REM: IF 512 POINTS, SET PLOT FOR 512 PTS
1365 WINDOW 1,512,0,255
1370 GO TO 1380
1374 REM: IF 256 POINTS, ONLY SET FOR 256 PTS
1375 WINDOW 1,256,0,255
1378 REM: MOVE TO ORIGIN OF PLOT
1380 MOVE 0,0
1385 REM: DRAW WAVEFORM
1390 DRAW X,Y

```

**Table 3
PRIORITY STORAGE PLAN**

Selected Vertical Mode(s)	Selected Storage Mode	CHOP/ALT	Display With SAVE REF Off	Ref Saved	Display With SAVE REF On
CH 1	a	b	CH 1 Only	CH 1	CH 1 and Ref
CH 2	a	b	CH 2 Only	CH 2	Ch 2 and Ref
ADD	a	b	ADD Only	ADD	ADD and Ref
CH 1, CH 2	a	ALT	CH 1 and CH 2	CH 1	CH 1 and Ref
CH 1, ADD	a	b	CH 1 and ADD	ADD	ADD and Ref
CH 2, ADD	a	b	CH 2 and ADD	ADD	ADD and Ref
CH 1, CH 2	NORM	CHOP	CHOP of CH 1/CH 2	CH 1/CH 2	CH 1/CH 2 and Ref
CH 1, CH 2, ADD	NORM	b	CHOP of CH 1/CH 2 and ALT ADD	ADD	ADD and Ref
CH 1, CH 2	ENV or AVG	b	CH 1 and CH 2	CH 1	CH 1 and Ref
CH 1, CH 2, ADD	ENV or AVG	b	CH 1 and ADD	ADD	ADD and Ref

^aNORM ENVELOPE, or AVG Storage Mode selected.

^bEither CHOP or ALT Vertical Mode selected.

```

838 REM: MOVE TO NEXT X PRINT FIELD
840 X1=X1+26.88
850 GO TO 580
860 REM: PICK UP WAVEFORM DATA. FIRST GET
HIGH BYTE COUNT.
865 RBYTE B1
869 REM: GET LOW BYTE OF BYTE COUNT.
870 RBYTE B2
872 REM: INITIALIZE CHECKSUM TO SUM OF HIGH
AND LOW BYTES
875 C=B1+B2
879 REM: CONVERT TWO BYTES OF COUNT TO ONE
NUMBER
880 B=B1*256+B2-1
885 REM: REDIMENSION WAVEFORM DATA
ARRAYS
886 DIM Y(B),X(B)
890 REM: READ IN WAVEFORM DATA POINTS
895 FOR I=1 TO B
900 RBYTE Y(I)
905 X(I)=1
908 REM: ADD BYTE TO CHECKSUM TOTAL
910 C=C+Y(I)
920 NEXT I
925 C=C-INT(C/256)*256
930 REM: READ IN CHECKSUM FROM GPIB NOW
935 RBYTE C1
936 REM: VERIFY CHECKSUM
940 IF C1+C<>256 THEN 990

```

```

950 REM: IF CHECKSUM WAS OKAY, GO AHEAD
AND DRAW WAVEFORM
960 GOSUB 1350
965 REM: GO BACK NOW AND SEE IF MORE
WAVEFORMS BEING SENT
970 GO TO 605
990 PRINT "CHECKSUM INCORRECT"
995 GO TO 8
999 REM:#####
1000 REM:#####
1001 REM:
1002 REM: INSTRUCTIONS FOR RUNNING THIS
PROGRAM
1003 REM:
1004 REM:-----
1005 PAGE
1006 PRI "THIS IS A PROGRAM TO DEMONSTRATE
THE GPIB OPTION OF THE 468."
1007 PRINT
1008 PRINT "INSTRUCTIONS:"
1009 PRINT
1010 PRINT "USER KEYS USED IN THIS PROGRAM:"
1011 PRINT
1012 PRINT "#1: STARTS THIS PROGRAM
RUNNING"
1013 PRINT
1014 PRINT "#2: ISSUES A DEVICE CLEAR TO THE
468 AND RESTARTS PROGRAM"
1015 PRINT

```

5. In this mode, the display responds to front-panel control changes with each sweep trigger, and the results of changes may be viewed each sweep. Waveforms acquired and displayed at low sweep rates require an increasing time to change as the sweep rate decreases (e.g., a waveform acquired at a sweep rate of 1 s per division requires approximately 10 seconds for the sweep time, and the triggering signal must be received after the sweep in progress is completed). Therefore, at the slower sweep speeds a longer delay is required before the display responds after changing a front-panel control.

NOTE

A signal displayed at 2, 1, and 0.5 mV per division is acquired at 5 mV per division and expanded vertically 2.5, 5, or 10 times in the steps of the VOLTS/DIV switch.

ENVELOPE STORAGE MODE DISPLAY

1. Obtain a Normal Sweep Display of the waveform to be stored.

2. Set TRIG MODE to NORM and adjust the A Trigger LEVEL control to obtain a stable display of the waveform to be stored. (This ensures that the trigger and the waveform to be stored are synchronized, especially on low-repetition-rate waveforms.)

3. Select either PRE TRIG Storage Window to acquire 7/8 of the waveform before the trigger event or POST TRIG Storage Window to acquire 7/8 of the waveform that occurs after the trigger.

4. Press the ENVELOPE Storage Mode push button in.

5. Change the number of sweeps to be accumulated in the waveform envelope display using the following procedure, if necessary. (The number is automatically set to 32 at power on.)

a. Press the NO. OF SWEEPS push button in. The seven-segment LED indicators will now display the number of sweeps to be accumulated.

b. Rotate the CURSOR/NO. of sweeps control knob either clockwise to increase the displayed number or counterclockwise to decrease the number.

```

635 P$=CHR(P)
638 REM:IF;, THEN END OF WFM ID OR END OF A
    WAVEFORM
640 IF P$=";" THEN 830
645 REM:IF %, MEANS BEGINNING OF WAVEFORM
    POINT DATA
650 IF P$="%" THEN 860
655 REM: IF ANYTHING OTHER THAN COLON, GO
    ON TO SEE IF SHOULD PRINT IT
660 IF P$<>":" THEN 710
665 REM: HAVE ENCOUNTERED A COLON: END OF
    FIELD, INCREMENT FIELD COUNT
670 F=F+1
675 REM:SEE IF WE HAVE ENCOUNTERED TOO
    MANY FIELDS (SHOULD HAVE 16 MAX)
680 IF F<16 THEN 700
685 REM:RESET FIELD COUNT TO 1 IF HAVE
    EXCEEDED COUNT OF 16
690 F=1
695 REM: TURN OUTPUT FLAG ON (1)
700 O=1
705 REM: CHECK FIELD #S TO SEE IF SHOULD
    PRINT THIS FIELD
710 IF F=1 THEN 760
720 IF F=4 THEN 760
730 IF F>5 and F<9 THEN 760
740 IF F>9 AND F<12 THEN 760
745 REM: IF NOT A FIELD TO BE PRINTED, GO
    BACK AND GET NEXT BYTE

```

```

750 GO TO 605
760 REM :SEE IF WE SHOULD PRINT THIS PART OF
    THE FIELD
765 IF O=0 THEN 605
766 REM: OUTPUT FLAG SET TRUE
769 REM: DON'T WANT TO PRINT COLONS
770 IF P$=":" THEN 605
775 REM: PRINT CHARACTER AND SUPPRESS LINE
    FEED
780 PRINT P$;
785 IF P$<>":" THEN 605
786 REM:COMMA MEANS END OF FIELD. TURN OFF
    OUTPUT FLAG.
790 O=0
794 REM: CHECK TO SEE IF WE SHOULD GO TO
    NEXT LINE OF SCREEN
795 REM: IF HAVE JUST FINISHED FIELD 1 OR 7,
    NEXT LINE
796 IF F=1 THEN 800
797 IF F=7 THEN 800
798 GO TO 605
800 REM: CHANGE YCOORD TO POINT TO NEXT
    LINE
810 Y1=Y1-2.816
820 GO TO 600
825 REM:HAVE COME TO END OF ID OR END OF
    WAVEFORM. RESET FIELD, OUTPUT
830 F=0
835 O=0

```

c. Press the NO. OF SWEEPS push button again to release it. The number on the display will count down as the sweeps are being acquired for the first storage cycle after the NO. OF SWEEPS push button is released. However, countdown begins as soon as a new selection is made, and the push button must be released immediately if it is desired to view the countdown. After the first ENVELOPE storage cycle countdown is completed, the LED display will be under the control of the CURSOR FUNCTION mode in use. The displayed number will not count down if the number of sweeps is set to 9999.

NOTE

The number of sweeps to be accumulated in the display is selectable from 1 to 256 in a binary sequence. The digital storage circuitry will display the resultant waveform with each sweep as the selected number of sweeps are acquired, then remove the resultant waveform and start the accumulations again in a repetitive cycle. An unlimited number of sweeps may also be selected (LED indicator display is 9999). In that case, the digital storage circuitry will continue to accumulate sweeps until the operator either makes a new number-of-sweeps selection or starts the accumulation cycle again by changing any oscilloscope front-panel control that will affect the data being acquired.

AVG STORAGE MODE DISPLAY

1. Obtain a Normal Sweep Display of the waveform to be stored.
2. Set oscilloscope TRIG MODE to NORM, and adjust the A Trigger LEVEL control to obtain a stable display of the waveform to be stored. (This ensures that the trigger and the waveform to be stored are synchronized, especially on low-repetition-rate waveforms.)
3. If waveforms are acquired at a TIME/DIV switch setting of $1 \mu\text{s}$ per division or faster, select either SINE Display Response for sinusoidal signals or PULSE Display Response for pulse-type signals.
4. Select either PRE TRIG Storage Window to acquire 7/8 of a waveform prior to the trigger or POST TRIG Storage Window to acquire 7/8 of a waveform occurring after the trigger.
5. Press the AVG Storage Mode push button in.

```

230 H=H+1
235 REM:SEE IF PAST QUEUE END;IF SO,WRAP
    AROUND TO BEGINNING
240 IF H<=10 THEN 260
250 H=1
255 REM: TURN SRQ ENABLE BACK ON
260 ON SRQ THEN 3000
265 GO TO 195
269 REM: POWER-ON SERVICE REQUEST ROUTINE
270 PRINT "POWER-ON SERVICE REQUEST
    RECEIVED"
275 PRINT
280 GO TO 220
289 REM:REQUEST TO SEND WAVEFORM
290 PRINT "READY TO SEND WAVEFORM"
295 PRINT
300 GOSUB 500
310 GO TO 220
320 REM:TALKER-ONLY SERVICE REQUEST
330 PRINT "TALKER-ONLY SERVICE REQUEST
    RECEIVED"
340 PRINT "UNABLE TO PROCESS REQUEST:
    ISSUING DEVICE CLEAR"
345 PRINT
350 GO TO 8
500 REM:#####
501 REM:
502 REM:SUBROUTINE TO ASSIGN TALKER AND
    PICK UP WAVEFORM
503 REM:

```

```

504 REM:#####
505 REM:SEND TAKE ADDRESS TO DEVICE
506 REM:ADD 64 TO DEVICE ADDRESS (SET BIT 7
    TO TALK DEVICE)
510 WBYTE @A+64:
515 PAGE
519 REM:CALL ROUTINE TO DRAW GRATICULE
520 GOSUB 6000
550 REM:SET FIELD TO 0
560 F=0
564 REM:SET OUTPUT FLAG TO FALSE (0)
565 O=0
568 REM:SET COORDINATES OF FIRST PRINT
    FIELD OF SCREEN
570 X1=0
580 Y1=98.176
585 REM:DEFINE LIMITS OF SCREEN
586 VIEWPORT 0,130,0,100
587 WINDOW 0,130,0,100
590 REM:PICK UP A BYTE AND DECIDE WHETHER
    OR NOT TO PRINT IT
600 MOVE X1,Y1
605 RBYTE P
606 IF E=0 THEN 609
607 E=0
608 RETURN
609 REM:CHECK INPUT
610 IF P<0 THEN 605
620 IF P=10 THEN 605
630 REM:CONVERT BYTE TO A CHARACTER

```

6. Change the number of sweeps to be accumulated in the display using the following procedure, if required. (The number is automatically set to 32 at power on.)

a. Press NO. OF SWEEPS push button in. The seven-segment LED indicators will now display the number of sweeps to be averaged.

b. Rotate the CURSOR/NO. OF SWEEPS control knob either clockwise to increase the displayed number or counterclockwise to decrease the number.

c. Press the NO. OF SWEEPS push button again to release it. The number on the display will count down as the sweeps are being acquired for the first storage cycle after the NO. OF SWEEPS push button is released. Averaging begins as soon as a new selection is made, so the push button must be released immediately if it is desired to view the countdown. After the first AVG storage cycle is completed, the LED display will be under the control of the CURSOR FUNCTION mode in use.

NOTE

The number of sweeps to be accumulated in the averaged waveform is selectable from 2 to 256 in a binary sequence. The digital storage circuitry will acquire the selected number of sweeps to be averaged, then display the averaged waveform while the required sweeps are being accumulated for the next averaged waveform. This cycle continues in a repetitive manner until a new mode is selected. Changing a front-panel control that affects the data being acquired will start the accumulation process over, to obtain the selected number of sweeps at the new control setting.

SAVE STORAGE MODE DISPLAY

1. Acquire a waveform in either NORM, ENVELOPE, or AVE (option) Storage Mode.

2. Press the SAVE Storage Mode push button in.

Driver Program

A sample program listing, useful when using the TEKTRONIX 4051 Active Terminal, is given below. This program will act as a driver for the TEKTRONIX 4050-Series Terminals to control a bus with the 468 connected. In order to handle the service request issued by the 468 as part of the power-up self-test, the driver program, or an operator-developed program, must be running when the 468 is powered up. This program will handle the 468 SRQ, copy the waveform message, and display the waveform with graticule and preamble.

```
1 ON SRQ THEN 2000
2 REM: FOR INSTRUCTIONS ON USING THIS
  PROGRAM, SEE LINE 1000
3 GO TO 100
4 REM USER KEY #1: RUNS PROGRAM FROM
  BEGINNING WITH INSTRUCTIONS
5 GO TO 100
8 REM:USER KEY #2: DEVICE CLEAR
9 WBYTE @20,95:
10 GO TO 100
12 REM:USER KEY #3: REQUEST WFM FROM
  INSTRUMENT
```

```
13 WBYTE @A+64:
14 RETURN
99 REM:NOTE THAT INIT SENDS AN IFC
100 INIT
105 GOSUB 1000
106 H=1
108 T=1
110 ON SRQ THEN 3000
120 ON EOI THEN 4000
130 SET KEY
140 DIM X(512),Y(512),Q(10),P$(1)
150 X=0
160 Y=0
175 E=0
180 REM:PROCESS REQUEST QUEUE
185 REM:THE QUEUE ALLOWS UP TO 9 SRQ'S TO
  BE RECEIVED AND SAVED FOR
186 REM:PROCESSING IF THIS PROGRAM IS
  ALREADY PROCESSING A PREVIOUSLY
187 REM:RECEIVED SRQ.
195 PRINT "WAITING FOR GPIB INTERRUPT"
200 IF H=T THEN 200
210 GO TO Q(H) OF 270,215,290,320
215 PRINT "ILLEGAL REQUEST"
219 REM:REMOVE REQUEST FROM QUEUE
220 Q(H)=0
223 REM:DON'T LET SRQ INTERRUPT NEXT FEW
  LINES
225 OFF SRQ
```

NOTE

NORM or continuous ENVELOPE acquisition stops immediately, and the displayed waveform is saved. Acquisition of data will stop at the end of a set ENVELOPE or AVG cycle in progress, and the new waveform will be saved. If a front-panel control setting is changed after the SAVE push button is pressed in but before an ENVELOPE or AVG cycle in progress is completed, the storage cycle will restart to obtain waveforms at the new control setting.

The SAVE display of a waveform acquired in the NORM or AVG Storage Mode with the TIME/DIV switch set to 1 μ s per division or faster, will be affected by the setting of the SINE or PULSE Display Response switch. If the ENVELOPE Storage Mode is selected and the number of sweeps to be accumulated is set to 9999, pressing the SAVE push button will immediately switch the 468 to the SAVE Storage Mode.

3. The SAVE Storage Mode display may be expanded up to 100 times depending on the setting of the TIME/DIV switch that controls the horizontal mode in operation when the waveform was acquired. Waveform data is expanded, using digital interpolation and analog gain. The display is expanded horizontally in both directions from the POST TRIG trigger point (data point 64) and is correctly scaled for

the TIME/DIV switch setting. (Data point 64 is approximately 1.3 horizontal graticule divisions from the beginning of the trace.) When a chopped waveform acquisition is used, the POST TRIG trigger point is data point 32.

4. The SAVE Storage Mode display may be expanded vertically up to 10 times depending on the setting of the VOLTS/DIV switch of the channel used for the data acquisition.

SAVE REF DISPLAY

1. Acquire a waveform in either NORM, ENVELOPE, or AVG (option) Storage Mode to be used as a reference waveform. Refer to Table 3 for a chart of the waveform stored as a reference with various combinations of Vertical Mode and Storage Mode selection.

2. Press the SAVE REF push button in. The reference waveform will be displayed in the vertical position at which it was acquired. It will not be further affected by any control knob or switch setting change on the oscilloscope front panel except the Horizontal POSITION control.

3. Press the SAVE REF push button again to release it and remove the reference waveform from the display. A new reference waveform will be saved each time the SAVE REF push button is pressed in.

$$y_n = 63 \text{ (assumed value)}$$

$$Y_0 = 0$$

$$SY = 40$$

$$YR = 43$$

$$Y\text{-units} = \text{mV}$$

Substituting these values into the equation for Y_n :

$$Y_n = Y_0 \times SY (y_n - YR)$$

$$Y_{14} = 0 + 40 (63 - 43)$$

$$Y_{14} = 40 (20) = 800$$

Adding the Y-units, we find that the absolute Y-coordinate value at data point 14 is:

$$Y_{14} = 800 \text{ mV.}$$

The positive value of Y_{14} indicates that the data point is located above the ground reference. Negative Y-coordinate values will be obtained for data points occurring below the ground reference. The Vertical POSITION control may be adjusted to place the ground reference at any desired location within the graticule area. Therefore the physical location

of any data point (along the vertical axis) is determined by the positioning of the ground reference.

Knowing that the vertical resolution is 25 data points per division and using the given Y-axis example value, the vertical displacement of data point 14 above the ground reference can then be calculated from the formula:

$$\text{Vertical displacement} = \frac{Y_n}{25 SY}$$

where the units of SY are as specified by the Y-units message element.

Substituting values into the formula, we obtain:

$$\begin{aligned} \text{Vertical displacement} &= \frac{800 \text{ mV}}{25 \text{ data points/div} \times 40 \text{ mV/data point}} \\ &= \frac{800 \text{ mV}}{1000 \text{ mV/div}} \\ &= 0.8 \text{ division above ground reference} \end{aligned}$$

OPERATOR'S CHECKS AND ADJUSTMENTS

To verify the operation and accuracy of your instrument, perform the following checks and adjustments before making a measurement. If adjustments are required beyond the scope of these operator's checks and adjustments, refer to a qualified service technician for instrument calibration. Before proceeding with these instructions, verify that the Line Voltage Selector switch (230/115) and the Regulating Range Selector switch (HIGH/LOW) are placed in the proper positions, and that the correct line fuse is installed for the ac-power-input source voltage, regulating range, and fuse selection. Verify that the POWER switch is OFF (push button out), then plug the power cord into the ac-power-input source outlet. Push the POWER switch in (ON) to apply power to the instrument and allow sufficient time for warm-up before proceeding with the following checks and adjustments. Warm-up time required to meet all the instrument's specification is 20 minutes.

TRACE ROTATION ADJUSTMENT

1. Obtain a Normal Sweep Display (refer to "Oscilloscope Displays" information in this manual).
2. Set the CH 1 AC-GND-DC switch to GND to display a free-running baseline trace with no vertical deflection.
3. Use the CH 1 Vertical POSITION control to move the trace to the center horizontal graticule line.

NOTE

Normally, the resulting trace will be parallel to the center horizontal graticule line, and the Trace Rotation adjustment should not be required.

4. If the resulting trace is not parallel to the center horizontal graticule line, use a small-bladed screwdriver to rotate the TRACE ROTATION adjustment screw, located just below the crt graticule (see Figure 4), to align the trace with the center horizontal graticule line.

Since there are 500 data points spanning the full 10 horizontal graticule divisions, the TIME/DIV switch setting can be found by the equation:

$$\begin{aligned} \text{TIME/DIV} \\ \text{switch} \\ \text{setting} &= \frac{500 \text{ DX}}{10} = 50 \text{ DX} \end{aligned}$$

where the units of DX are as specified by the X-units message element.

Substituting values into the formula, we obtain:

$$\begin{aligned} \text{TIME/DIV switch setting} &= 50 \text{ data points/div} \times 40 \text{ ns/} \\ &\quad \text{data point} \\ &= 2000 \text{ ns/div} \\ &= 2 \mu\text{s/div} \end{aligned}$$

The horizontal distance of data point 14 from the beginning of the trace can then be calculated from the formula:

$$\text{Horizontal distance} = \frac{\text{DX (n)}}{\text{TIME/DIV switch setting}}$$

Substituting values into the formula, we obtain:

$$\begin{aligned} \text{Horizontal distance} &= \frac{40 \text{ ns/data point} \times 14 \text{ data points}}{2 \mu\text{s/div}} \\ &= \frac{560 \text{ ns}}{2 \mu\text{s/div}} = \frac{0.56 \mu\text{s}}{2 \mu\text{s/div}} \\ &= 0.28 \text{ division} \end{aligned}$$

The horizontal distance from the beginning of the trace at which the trigger occurs can also be calculated using the same formula:

$$\begin{aligned} \text{Horizontal distance} &= \frac{40 \text{ ns/data point} \times 64 \text{ data points}}{2 \mu\text{s/div}} \\ &= \frac{2500 \text{ ns}}{2 \mu\text{s/div}} = \frac{2.5 \mu\text{s}}{2 \mu\text{s/div}} \\ &= 1.25 \text{ divisions} \end{aligned}$$

Y-COORDINATE VALUES. In a similar manner the absolute value of the Y-coordinate at data point 14 can also be calculated using the transmitted information. Continuing with the preceding example, the following Y-axis values are obtained from the sample message:

PROBE COMPENSATION

Misadjustment of probe compensation is one of the sources of measurement error. Most attenuator probes are equipped with compensation adjustments. To ensure optimum measurement accuracy, always compensate the oscilloscope probe before making measurements. Probe compensation is accomplished as follows:

1. Connect the two, 10X probes (supplied with the instrument) to the Channel input connectors.

2. Set both VOLTS/DIV switches to 0.1 V and set both the AC-GND-DC switches (input coupling) to DC.

3. Select the CH 1 VERT MODE, and connect the tip of the probe attached to the Channel 1 input connector to the CALIBRATOR Loop.

4. Using the approximately 1 kHz CALIBRATOR square-wave signal as the input signal, obtain a Normal Sweep Display presentation (see "Oscilloscope Displays" information in this manual).

5. Set the A TIME/DIV switch to display several cycles of the CALIBRATOR signal. Use the Channel 1 POSITION control to vertically center the display.

6. Check the waveform presentation for overshoot and rounding (see Figure 13). Readjust the probe compensation, if necessary, for flat tops on the waveforms. Refer to the instructions supplied with the probe for the compensation adjustment procedure.

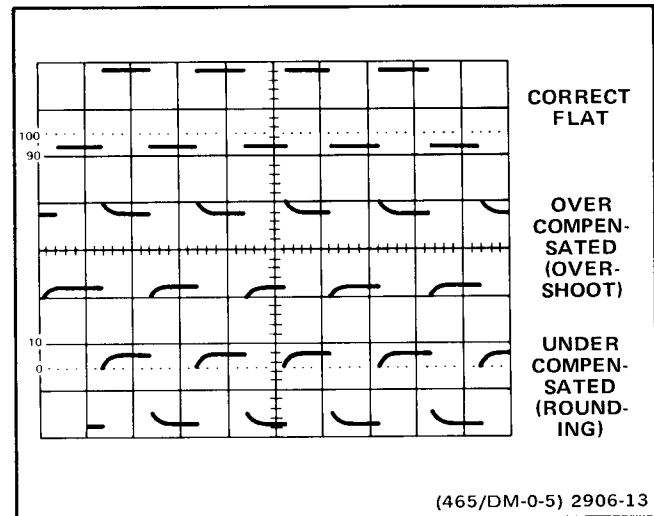

Figure 13. Probe compensation.

where the symbols used are defined as follows:

X_n, Y_n :: = Absolute X- and Y-coordinate values at point n.

n :: = data point number in the waveform curve ($n = 1, 2, 3, \dots, 512$).

DX :: = X-increment (horizontal distance between data points).

NO :: = X-point offset (trigger point).

$X0$:: = X-origin.

$Y0$:: = Y-origin.

SY :: = Y-multiplier (scaling factor).

y_n :: = Y-data point value.

YR :: = Y-value offset (ground reference).

X-COORDINATE VALUES. For example, the following information obtained from a sample message is used to find the X-coordinate of data point 14.

$n = 14$
 $X0 = 0$
 $DX = 40$
 $NO = 64$
 $X\text{-units} = ns$

Substituting these values into the formula for X_n :

$$X_{14} = 0 + 40 (14 - 64)$$

$$X_{14} = 40 (-50) = -2000.$$

Adding the X-units, we find that the absolute coordinate value at data point 14 with respect to the trigger point ($NO = 64$) is:

$$X_{14} = 2000 \text{ ns} = -2 \mu\text{s}.$$

Positive X-coordinate values will be obtained for data points occurring after the trigger point.

NOTE

The position of the trigger point is determined by the selection of either PRE TRIG or POST TRIG Storage Window and by the manner in which dual-trace waveforms are stored (either ALT or CHOP).

The TIME/DIV switch setting and the horizontal graticule locations of data points 14 and 64 (trigger point) can then be determined from the X-increment, X-units, and absolute X-coordinate values.

7. Select the CH 2 VERT MODE and release the CH 1 VERT MODE button. Connect the Channel 2 probe tip to the CALIBRATOR Loop.

8. Use the Channel 2 POSITION control to vertically center the display, and repeat the procedure of step 6 for the Channel 2 probe.

9. Disconnect the 10X probes from the instrument if they are not used for additional checks.

2. Connect two 10X probes supplied with the oscilloscope to the CH 1 and CH 2 input connectors. Connect the probe tips to the CALIBRATOR Loop on the instrument front panel.

3. Use CH 1 Vertical POSITION control to set the top of the Channel 1 display to the top horizontal graticule line and use Horizontal POSITION control to set the start of the sweep to the left vertical graticule line.

4. Use CH 2 Vertical POSITION control to set the bottom of the Channel 2 display to the bottom horizontal graticule line.

5. Adjust Trigger LEVEL for a stable, triggered display.

6. Adjust FOCUS control for best defined display.

7. CHECK—for a well-defined display over entire crt graticule area.

ASTIGMATISM ADJUSTMENT

1. Preset the instrument controls as for obtaining a Normal Sweep Display with the following exceptions:

VERT MODE	ALT
VOLT/DIV	0.1 V
TIME/DIV (both)	1 ms
Trigger SOURCE	CH 1
AC-GND-DC (both)	DC
INTENSITY	Visible display

These defined elements contain the waveform data and are further broken down as follows:

<BINARY COUNT>::=

(A two-byte binary integer to specify the number of data bytes plus the checksum byte—data bytes + 1. The high-order byte is sent before the low-order byte.)

≪BINARY DATA POINTS>

(The binary value of the waveform at a specific data point.) This area contains a binary data-point-defined element for each data point in the waveform message.

<CHECKSUM>::=

(The two's complement of the modulo 256 sum of the preceding binary data bytes and the binary count bytes. Does not include the % symbol preceding the binary count.) After the binary information of all the displayed waveforms is transmitted, the message is ended with the terminator.

<TERMINATOR>::=LF&EOI

(Line Feed and End or Identify). Line Feed sent concurrently with End or Identify terminates the message transmission.

The following example illustrates a typical waveform message with the ID element added to make a complete message.

```
ID TEK/468,V79.1,FV:1.0;WFMPRE WFID:"CH1
DC",NR.PT:512,PT.FMT:Y,XINCR:40,XZERO:0,PT.
OFF:64,XUNITS:NS,YMULT:40,YZERO:0,YOFF:43,
YUNIT:MV,ENCDG:BIN,BN.FMT:RP,BYT/NR:1,BIT/
NR:8,%<BINARY COUNT> <BINARY DATA
POINT>...<CHECKSUM>LF&EOI
```

A more detailed explanation of the codes and formats is contained in Tektronix Standard—General Purpose Interface Bus (GPIB, Codes and Formats (Rev. C).

Calculating Coordinate Values

The absolute coordinate values of the waveform data points are calculated using the information obtained from the message. In the point format used (PT.FMT:Y), only the Y-values are transmitted; the X-values are determined from both the data point number and the X-increment value. The transmitted data is used in the following formulas:

$$X_n = X_0 + DX (n - N_0) \text{ and}$$

$$Y_n = Y_0 + SY (y_n - YR),$$

8. If focusing is not uniform over the entire graticule area, use a small-bladed screwdriver to adjust the ASTIG control (located just below the crt graticule) for best definition.

9. ASTIG adjustment and FOCUS control interact. Repeat both steps 6 and 8 for the best defined display over entire crt graticule area.

4. Adjust Trigger LEVEL control for a stable display of the CALIBRATOR signal.

5. Use Vertical POSITION control to vertically center the display between the 2nd and 8th horizontal graticule lines.

6. CHECK—for a vertical display amplitude of 6 divisions ± 0.2 division (5.8 to 6.2 div) (see Figure 14).

VERTICAL GAIN CHECK

1. Preset the instrument controls to obtain a Normal Sweep Display (see Oscilloscope Displays) with the following exceptions:

VOLTS/DIV (both)	5 mV (50 mV with 10X probe)
TIME/DIV (both)	1 ms
AC-GND-DC	DC

2. Connect a 10X probe (supplied with the instrument) to the CH 1 input connector. Connect the probe tip to the CALIBRATOR Loop on the instrument front panel.

3. Adjust INTENSITY for the desired display brightness and adjust FOCUS control for best defined display.

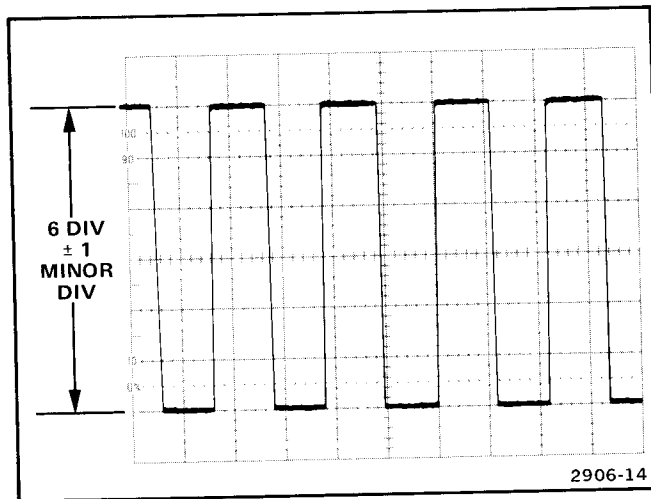

Figure 14. Vertical display accuracy.

X UNITS are used with the X INCREMENTS for the time scale of the waveform.

<Y MULTIPLIER>::=Y MULT:{200;400;800;2;4;8;20;40;80;25;50;100;250;500;1000}

The defined element is a vertical scaling quantity determined by the VOLTS/DIV setting.

<Y ORIGIN>::=YZERO:0

Y ORIGIN is defined as zero.

<Y VALUE OFFSET>::=YOFF:<GND REF VALUE>

The defined element is the value of the vertical position of ground reference.

<Y UNITS>::=YUNIT:{V;MV;UV;DIV}

Defined element is the unit attached to the vertical value of each data point.

NOTE

For instruments with Option 02 (GPIB), a firmware bug exists in both version 1.0 and version 2.0 ROM. This causes an incorrect transmission of the Y-multi-

plier and the Y-units of a waveform whenever the acquired waveform is vertically uncalibrated or when an ADD display is obtained with unequal VOLTS/DIV switch settings. To avoid this bug, rotate the VAR VOLTS/DIV controls into the detent position and use the same VOLTS/DIV switch setting on both channels for ADD displays when acquiring the data for transmission.

<DATA ENCODING>::=ENCDG:BIN

Curve data encoding is in low-level binary code.

<BINARY FORMAT>::=BN.FMT:RP

Each number sent is a binary, positive integer.

<BYTES PER NUMBER>::=BYT/NR:1

One byte is sent for each number.

<BITS PER NUMBER>::=BIT/NR:8

Eight bits are in each byte. This ends the message preamble. The message continues with the waveform binary information.

<BLOCK BINARY CURVE>::=%<BINARY COUNT>

<BINARY DATA POINT>...<CHECKSUM>

EXTERNAL HORIZONTAL GAIN CHECK

1. Perform steps 1 through 4 of the Vertical Gain Check procedure to obtain a stable display of the CALIBRATOR signal.
2. Set the A TIME/DIV switch to the X-Y position.
3. Use the Horizontal POSITION control to move both dots within the graticule area.
4. CHECK—for a display of two dots separated horizontally by 6 divisions ± 0.25 division (5.75 to 6.25 div).
5. Set the A TIME/DIV switch back to 1 ms.

NOTE

Perform the following Digital Storage checks in the sequence presented.

VERTICAL DEFLECTION ACCURACY CHECK

1. Perform the Vertical Gain Check procedure.
2. Adjust the Trigger LEVEL control for a stable, triggered display and press the NORM Storage Mode push button in.
3. Use the CH 1 POSITION control to vertically center the display and check for a stored display with a vertical amplitude of 6 divisions ± 0.2 divisions (5.8 to 6.2 div). (See Figure 14.)
4. Remove the 10X probe from the CH 1 input connector.

VOLTS CURSOR ACCURACY CHECK

1. Ensure that the VERT MODE is set to CH 1 only, and set the CH 1 AC-GND-DC switch to GND. Check that the CH 1 VOLTS/DIV switch is set to 5 mV and that the VAR control is in the calibrated detent.

NOTE

All punctuation, including spaces, must be as shown.

The waveform element is in the following format:

<WAVEFORM> ::= <PREAMBLE>, <BLOCK
BINARY CURVE>

These message elements are further defined as follows:

<PREAMBLE> ::= WFMPRE <WPA>[{,<WPA>}...]

Where <WPA> ::= (WAVEFORM PREAMBLE
ARGUMENTS)

The following waveform preamble arguments are listed in the order in which they are transmitted in a message. After each, a brief description is given.

<WAVEFORM ID> ::= WFID:"{CH1:CH2:ADD}
{AC:DC:GND:UNK}"

The defined elements of <WAVEFORM ID> are: the Vertical Mode selected for the waveform, the Input Coupling, and the Storage Mode. UNK will be sent for the Input Coupling when ADD is sent and when the Input Coupling is not the same for both channels.

<NUMBER OF POINTS> ::= NR.PT:{256:512}

The defined element is the length of the data record for the waveform being transmitted (256 or 512).

<POINT FORMAT> ::= PT.FMT:Y

The Y-coordinate is transmitted, but the X-coordinate is determined from the data point number and the X INCREMENT.

<X INCREMENT> ::= XINCR:{100:40:20:10:4:2:1:
400:200}

The defined element increment multiplied by the X UNITS is the time between data points.

<X ORIGIN> ::= XZERO:0

X ORIGIN is defined as zero.

<POINT OFFSET> ::= PT.OFF;{32:64:224:448}

The defined element is the trigger point, determined by the STORAGE WINDOW (PRE TRIG or POST TRIG). Actual trigger point is within ± 3 of the given example values for point offset.

<X UNITS> ::= XUNIT: {S:MS:US:NS}

2. Use the CH 1 Vertical POSITION control to align the baseline trace with the center horizontal graticule line.

3. Select VOLTS cursors and use CURSOR control knob to set the active cursor (dashed horizontal line) to the second horizontal graticule line from the bottom of the crt.

4. Use the CURSOR SELECT push button to activate the second cursor.

5. Adjust the CURSOR control knob to obtain a readout display of 30.0 mV.

6. CHECK—display for 6 divisions ± 0.2 division (5.8 to 6.2 div) between voltage cursors (see Figure 15).

TIME CURSOR ACCURACY CHECK

1. Ensure that the A and B TIME/DIV switches are set to 1 ms.

2. Select the TIME cursors and adjust the INTENSITY control as necessary to make the cursor dots distinguishable from the trace.

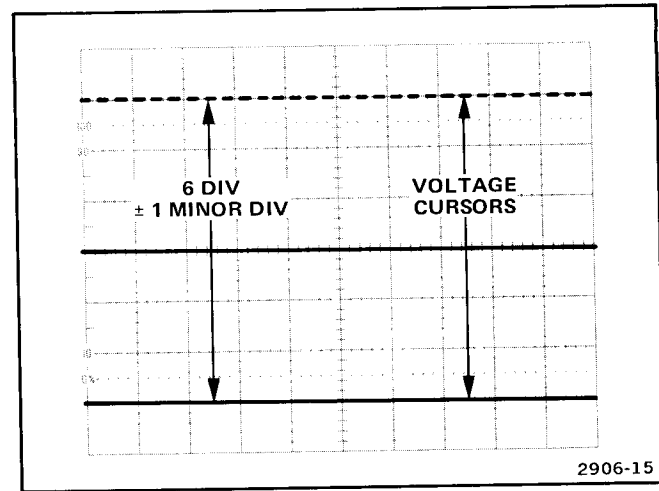

Figure 15. VOLTS cursor accuracy.

3. Use the CURSOR control knob to set the active cursor to the second vertical graticule line from the left edge of the crt.

4. Use CURSOR SELECT push button to activate the other cursor.

Table 7
BNF SYMBOL NOTATION

Symbol	Definition
<>	Defined element.
::=	Is defined as.
()	Explanation.
{ }	Grouping.
[]	Optional, may be omitted.
!	Exclusive OR.
&	AND – designates concurrent messages on the bus (the element on the right of & is concurrent with the last element of the expression on the left.
"	String argument delimiter.
:	Link argument delimiter.
;	Message unit delimiter.
,	Argument delimiter.
%	Preceded a binary block argument.

The transmitted message is in the following format:

```
<MESSAGE> ::= <ID> ;
[<WAVEFORM>[ ; <WAVEFORM>]]]
<TERMINATOR>
```

Each defined element is further broken down as follows:

```
<ID> ::= ID <SCOPE TYPE>,<C AND F
VERSION>,<FIRMWARE VERSION>
```

These message elements are further defined as follows:

```
<SCOPE TYPE> ::= TEK/468 (Identifies the instrument
as a Tektronix 468 Digital Storage Oscilloscope).
```

```
<C AND F VERSION> ::= V79.1 (States the version of
Tektronix Standard GPIB Codes and Formats in
use-Version 79.1).
```

```
<FIRMWARE VERSION> ::= FV:00000 (States the
firmware version installed in the instrument).
```

An example of the identification element is:

```
ID TEK/468,V79.1,FV:1.0
```

5. Adjust the CURSOR control knob to obtain a readout display of 8.00 ms.

6. CHECK—display for 8 divisions ± 0.2 division (7.8 to 8.2 div) between time cursors (see Figure 16).

NOTE

This procedure also provides a check of the horizontal deflection accuracy.

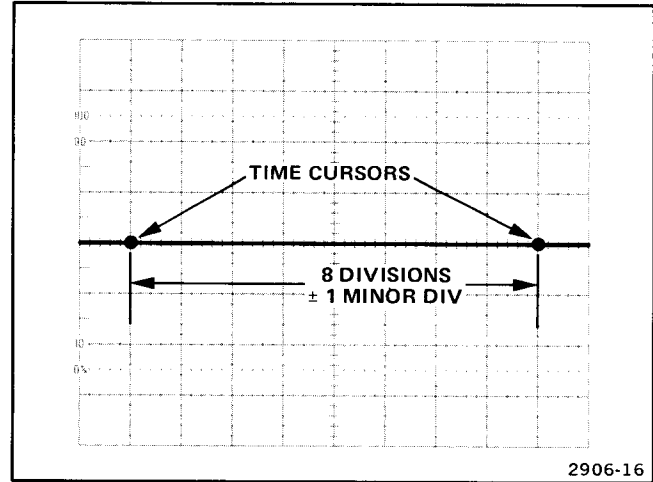

Figure 16. TIME cursor accuracy.

If a Device Clear (DCL) message is received by the 468 during a transmission, the 468 stops transmitting and moves to a state equivalent to a completed transmission. The MTA message must be sent by the controller before another transmission can begin. A DCL message will not turn off the SRQ issued by the 468 as part of the power-on routine. To remove the power-on SRQ, the instrument must first be made a talker and the status byte sent. This ensures that the bus controller knows the 468 is powered up on the bus.

468 Message

The message sent by the 468 conforms to Tektronix Standard-General Purpose Interface Bus (GPIB), Codes and Formats, Revision C and Appendices.

The term "message" as used here, refers to a device-dependent remote message. It is not an interface message, and it does not interfere with interface message coding or use.

A message represents a given amount of information, with the beginning and ending clearly defined. It is communicated between the 468 (as a talker) and one or more devices acting as listeners. The message begins when the 468 first begins functioning as a talker and receiving devices begin functioning as listeners.

Message Format. A waveform message consists of an identification block and 0, 1, 2, or 3 waveforms, separated by delimiters. The following message format is described using BNF notation. The BNF symbols used are defined in Table 7.

MAKING DIGITAL STORAGE MEASUREMENTS

The following procedures will enable the operator to perform some of the basic measurements and familiarize the operator with digital storage measurement techniques. Read the "Operating Considerations" section in this manual for information on signal connections, grounding, and other general operation information that may be useful in your application.

AC PEAK-TO-PEAK VOLTAGE

NOTE

Either channel input connector may be used for the signal input. Use the VERT MODE switch to select the appropriate channel for display.

1. Acquire the waveform to be measured in the NORM Storage Mode (see NORM Storage Mode Display procedure). The display in this mode responds, with each trigger, to front-panel control changes, and the results of changes may be viewed each sweep. Use a VOLTS/DIV setting that gives the desired vertical deflection. Ensure that the VOLTS/DIV VAR control is in the calibrated detent. Set the TIME/DIV switch to display several cycles of the waveform.

NOTE

The AVG Storage Mode may be used to acquire low-amplitude signals and eliminate or reduce the accompanying noise (see AVG Storage Mode Display). Noise is reduced in direct proportion to the square root of the number of sweeps averaged.

2. Select VOLTS CURSOR FUNCTION. Two horizontal lines will be displayed along with the waveform to be measured. The dashed line is the active cursor.

3. Use the CURSOR/NO. OF SWEEPS control knob (referred to as CURSOR knob in the following steps) to move the active cursor to either peak of the waveform.

Table 6
468 STATUS BYTES

STATUS		Status Byte			
		Binary	Octal	Hexadecimal	Decimal
SRQ ASSERTED	POWER ON	01000001	101	41	65
	TRANSMIT RQST	11000011	303	C3	195
	TON TRANSMIT RQST	11000100	304	C4	196
SRQ NOT ASSERTED	POWER ON	00000001	001	01	1
	TRANSMIT RQST	10000011	203	83	131
	TON TRANSMIT RQST	10000100	204	84	132
	NO STATUS	00000000	000	00	0

The method of interruption may determine what action takes place to restart the 468 transmission. If no data is lost, the controller can reassign listeners and remove attention (ATN) to cause the 468 to resume transmission at the point of interruption. If data was lost, the controller might send a device clear (DCL) to reset the 468 (and all the listeners on the bus) and assign listeners. It will then send the 468 tal address to restart the waveform transmission.

468 GPIB Message Protocol

When the 468 is connected to a bus having a bus controller, it will send a message whenever it receives its talk address (MTA). The talk address is set by the GPIB switch located on the 468 rear panel (see GPIB Switch Operation).

4. Push the CURSOR SELECT button (center of CURSOR control knob) to active the other cursor, and use the CURSOR control knob to move the cursor to the opposite peak of the waveform (see Figure 17).

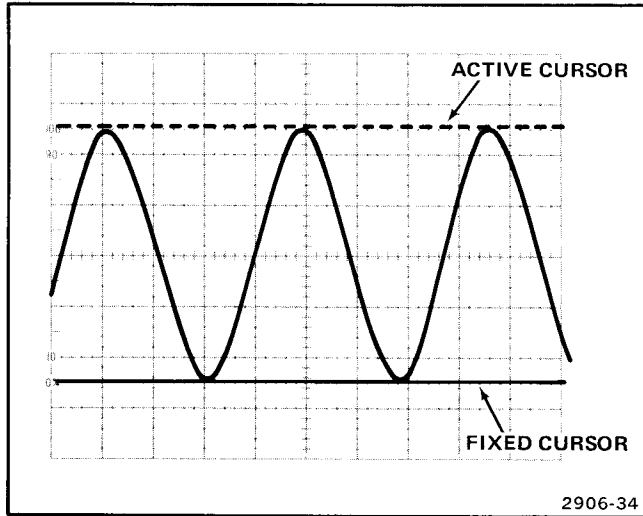

Figure 17. Ac peak-to-peak voltage, cursor method.

NOTE

For early serial number instruments with firmware version 1.0, a minor firmware bug can occur when making voltage cursor measurements in the SAVE Storage Mode. The bug occurs when the voltage cursors are positioned at or within 0.05 division of the following spacings: together (one cursor superimposed over the other), 2.5 divisions apart, 5 divisions apart, and 7.5 divisions apart. Under these conditions, an incorrect voltage readout can appear in the seven-segment LED display. (If a 10X scale-factor-switching probe is used to acquire the displayed signal, the incorrect readout can occur over a range of up to 0.6 graticule division at each of the preceding voltage cursor spacings.)

Occurrence of the bug can be recognized by a decimal point shift in the seven-segment LED display. The digits displayed usually change, but not in every instance.

Instruments equipped with firmware version 2.0 or higher have had the VOLTS cursor readout anomaly eliminated. If the instrument is known or suspected to contain firmware version 1.0, the following methods enable the user to compensate for the previously described anomaly.

GPIB Status Indicator

The GPIB Status LED ($\overline{\text{TIDS}}/\text{SRQ}$), located on the left side panel of the digital storage section, will be illuminated red when the service request (SRQ) is issued by the 468. During the serial poll (when the status byte is sent), it will flash green. During the transmission of data, it will be illuminated green to indicate to the user that the interface is not in the talker-idle state (TIDS).

GPIB Status Bytes

Status information relating to the state of the 468 GPIB interface is sent to the controller in the status byte during a serial poll. Two possible conditions exist: status with a service request asserted and status with no service request asserted. Table 6 contains a listing of the status bytes available.

When the controller is responding to a service request from another device, the 468 status bytes without a service request asserted tell the controller the state of the 468.

After the other device service request is handled, the controller uses the status reported by all the devices on the bus to determine what action occurs next. The action depends on controller programming.

As an example, assume that the 468 is in the middle of a transmission and some other device on the bus issues a service request. The controller interrupts the transmission of the 468 by asserting attention (ATN) TRUE, and then does a serial poll to determine the status of each device on the bus. Having handled the service request, the controller can then use the status reported by the 468 to restart or continue the transmission.

The controller may interrupt the transmission either synchronously (in step with the handshake) or asynchronously (no regard to handshake progress). If the controller interrupts synchronously, the last data byte sent will be data accepted (DAC) by all the assigned listeners, and it will not be lost. An asynchronous interruption may or may not cause the loss of a byte, depending upon the point of interruption.

- a. Use the *COUPLED V/T CURSOR FUNCTION*. The voltage readout appearing in the seven-segment LED display will be correct.

- b. If an off-waveform voltage measurement must be made, use *NORMAL Storage Mode*. *SAVE Storage Mode* is the only function affected by the bug.

- c. Check the readout (that appears in the seven-segment LED display) against the graticule and *VOLTS/DIV* switch setting when making measurements over the small ranges affected when the voltage cursors are spaced at 2.5-graticule-division multiples when operating in *SAVE Storage Mode*.

For later serial number instruments, after the waveform is acquired, the SAVE Storage Mode may be selected. This mode holds the waveform frozen and reduces the amount of cursor jitter seen in the display. The SAVE display may be expanded horizontally and vertically for more detailed examination of the waveform (see SAVE Storage Mode Display).

5. Read the peak-to-peak amplitude on the four-digit LED display; the scale factor is indicated by the red illuminated scale factor LED on the right side of the four-digit display. The top LED is volts (V), the middle one is millivolts (mV), and the bottom one is divisions (DIV). (Divisions will be indicated if the *VOLTS/DIV VAR* control is out of the calibrated detent.)

INSTANTANEOUS DC VOLTAGE

NOTE

Either channel input connector may be used for the signal input. Use the VERT MODE switch to select the appropriate channel for display.

1. Obtain a Normal Sweep Display (refer to Oscilloscope Displays procedures in this manual). Make sure that the *VOLTS/DIV VAR* control is in the calibrated detent.

2. Determine the polarity of the voltage to be measured as follows:

mode, the 468 is permanently addressed as a talker and does not require receipt of its talk address (MTA) before commencing a message transmission. The message to be sent depends on the state of the interface when the ATN message is removed. If the interface is in the serial-poll-active state (SPAS), a status byte will be sent; and if the interface is in the talker-active state (TACS), a waveform message will be sent.

NOTE

If the 468 is in the TALK ONLY mode, a bus controller cannot assign any other talkers on the bus. Therefore, when operating with a bus controller, the TALK ONLY switch should be OFF. The TALK ONLY switch must be set to ON when the bus has only listeners and when there is no controller to respond to a service request.

Power-Up State

The state of the GPIB existing when the 468 is powered up is as follows:

1. If the 468 is powered on during a transmission on the bus, an error may occur in the handshake routine.

2. A power-on service request is issued. The power-on service request must be handled by a controller to remove it from the bus. When a controller receives the power-on status byte, it may reinitiate a bus transmission if one was in progress during the 468 power-on period.

3. The 468 interface is in the talker-idle and serial-poll-idle states.

4. Each power up completely resets the 468 interface, and the interface will be ready to transmit waveform data as soon as the 468 power-up routine is completed.

NOTE

When no waveform has been acquired, only the instrument ID portion of the waveform message will be transmitted.

Power-Down State

The 468 does not have any capability for handling momentary power interrupts. No settings are retained on power down, and no power-down routine is used. If the power level drops below the logic circuitry operating level, the 468 will fail in its processing.

a. Set the AC-GND-DC switch to GND and vertically position the baseline trace to the center horizontal graticule line.

b. Set the AC-GND-DC switch to DC.

If the waveform moves above the center line of the crt, the voltage is positive.

If the waveform moves below the center line of the crt, the voltage is negative.

3. Set the AC-GND-DC switch to GND and select the NORM Storage Mode. If the channel signal is being used as the internal trigger source, ensure that the Trigger Mode switch is set to AUTO.

4. Use the appropriate channel Vertical POSITION control to move the baseline trace to a convenient reference line. For example, if the voltage to be measured is positive, position the baseline trace to the bottom graticule line; if negative, position the baseline trace to the top graticule line; and if the voltage is an alternating signal, position the baseline trace to the center graticule line.

NOTE

If the ground reference is set more than ± 5 divisions from the center horizontal graticule line, the ground reference will not be stored. When using ADD Vertical Mode, both channel input coupling switches must be in GND to store a ground reference dot.

5. Switch the selected channel AC-GND-DC switch back to DC. A bright ground reference dot will be visible at the left edge of the crt graticule lines.

NOTE

If the vertical position of the display is moved after the ground reference is stored, the dot is no longer a valid reference. Also, the accuracy of the ground dot is affected by dc offsets due to thermal drift and balance (DC and INVERT) adjustments. Additionally, if the AC-GND-DC switch is set to AC, the location of the ground reference dot will indicate the average value of the ac component of a waveform.

6. Select VOLTS cursors and position the active cursor to the ground reference point.

TALK ONLY ON. When the 468 is in the TALK ONLY mode, the controller has less control of the 468 GPIB interface. In this mode the 468 will never enter the talker idle state (TIDS), because it is permanently addressed as a talker. The TALK ONLY mode is most useful when there is no controller on the bus, and the 468 is used to transmit waveform data to a listener. In the TALK ONLY mode with no bus controller, a typical series of actions that may occur when the operator wants to send a waveform is as follows:

1. The TRANSMIT button is pressed in.
2. A service request (SRQ) is sent, and the 468 begins to handshake the waveform data to a listener.
3. The transmission is completed, the message is terminated with line feed (LF) and end or identify (EOI), and the SRQ message is removed.

In the TALK ONLY mode with a controller on the bus, a typical series of actions that may occur when the operator wants to send a waveform is as follows:

1. The TRANSMIT button is pressed in.

2. The SRQ message is sent, and the 468 begins the handshake routine. At this point a controller may interrupt to respond to the SRQ and perform a serial poll. A response from the controller is not necessary; and if listeners are on the bus, the 468 GPIB interface will send the waveform message unless interrupted. If a controller either performs a serial poll or interrupts the message for any reason, the 468 will resume transmitting the message as soon as ATN is removed if it is out of the serial poll mode.

3. Again, the waveform message is terminated with LF and EOI, and the SRQ message is removed.

NOTE

If a listener or controller is not present to receive the waveform data when the TRANSMIT button is pressed, the 468 will remain in the SAVE Storage Mode while attempting to send the message. To exit this condition, it is necessary to cycle the POWER switch OFF, then ON again.

When a bus controller is used, any ATN message on the bus will cause the 468 interface to respond with a message when the ATN message is removed. In the TALK ONLY

7. Press in the **CURSOR SELECT** button to activate the other **VOLTS** cursor. The nonmoving cursor is now the 0-volt reference for making measurements on the waveform.

NOTE

*Instruments equipped with firmware version 2.0 or higher enable the operator to automatically align a voltage cursor with a previously acquired ground dot when **COUPLED V/T** measurement mode is selected. On these instruments, rotate the **CURSOR** knob counterclockwise into the end-stop spring and hold it until the dashed cursor attached to the ground dot. Press the **CURSOR SELECT** push button to hold the cursor fixed and activate the other **VOLTS** cursor. Re-activate the fixed cursor and rotate the **CURSOR** knob clockwise to resume the normal **COUPLED V/T** mode. If the **VOLTS** cursor does not attach to the ground dot, reacquire a valid ground dot. The **VOLTS** cursor will now attach to the ground dot as previously described*

8. Use the **CURSOR** control knob to move the dashed **VOLTS** cursor to the point of interest on the waveform (see Figure 18). Read the instantaneous dc voltage from the four-digit LED display. If the dashed cursor is above the

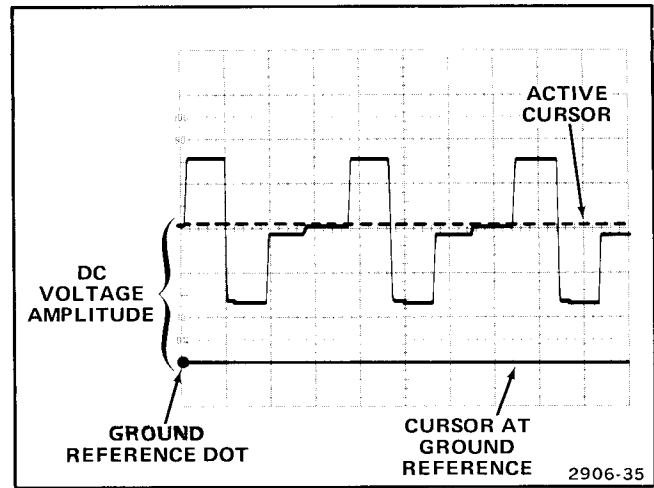

Figure 18. Instantaneous dc voltage, cursor method.

ground reference, the voltage is positive; and if it is below the ground reference, the voltage is negative.

TIME DURATION

1. Acquire the waveform to be measured in the **NORM Storage Mode**. (See the **NORM Storage Mode Display** procedure for acquiring a waveform.)

a. Controller asserts the attention message (ATN) TRUE to gain control of the bus, then sends unlisten (UNL) and untalk (UNT). This prevents the listeners from receiving status bytes and prevents the current talker from sending data when the ATN is removed.

b. Controller then sends the serial-poll-enable message (SPE) to place all devices on the bus in the serial-poll mode.

c. During the poll, the controller sends ATN and each device's talk address (MTA), one at a time. As each device receives its own talk address, the controller will remove the ATN message, and the addressed device will send its status byte. The status byte will indicate to the controller each device's present state and which one(s) require servicing. (The 468 status byte will indicate that a waveform is available when the TRANSMIT button has been pressed.)

NOTE

The 468 will send (or attempt to send) its status byte as soon as the controller removes the ATN message. Should the controller fail to assign a listener for the status byte, the 468 status byte will be lost when ATN is asserted TRUE at a later time.

d. Upon finishing the serial poll, the controller sends ATN and the serial-poll-disable message (SPD), placing all devices in the serial-poll-idle state.

4. After the poll, the controller may reconfigure the bus, assigning listeners to receive the waveform data, if necessary.

5. With the listeners assigned, the controller then sends the 468 its talk address (MTA) to make the 468 a talker. When the controller removes the ATN message this time, the 468 sends waveform data. The waveform message is then handshaked out to the listeners, one byte at a time, and the message is terminated by the 468 sending LF (line feed) and EOI (end or identify) concurrently.

NOTE

Once the waveform message is completed and EOI sent, the 468 must receive its My Talk Address (MTA) again before it will transmit any other messages. The controller cannot cause the 468 to be a permanent talker.

Under the direction of a bus controller, the 468 will initiate a message transmission whenever it receives its talk address. Either a status byte or a waveform message (depending on the state of the 468 GPIB interface when the MTA is sent) will be transmitted by the 468, when the controller removes the ATN message.

2. Set the TIME/DIV switch to display one complete period of the waveform to be measured, and set the VOLTS/DIV switch to obtain the desired vertical deflection.

3. Position the display to place the time measurement points on the center horizontal graticule line (see Figure 19).

4. Select the TIME cursors and use the CURSOR control knob to move the active cursor dot to the intersection of the leading edge of the waveform and the center horizontal graticule line.

5. Press in the CURSOR SELECT button to activate the other cursor dot. Use the CURSOR control knob to position the cursor dot to the intersection of the start of the next cycle and the center horizontal graticule line.

6. Read the time duration (between the cursor dots) from the four-digit, seven-segment LED indicators. The scale factor of the measurement is indicated by the illuminated green scale-factor LED on the right side of the seven-segment indicators. When illuminated, the top LED indicates seconds (s), the middle one milliseconds (ms), and the bottom one microseconds (μs).

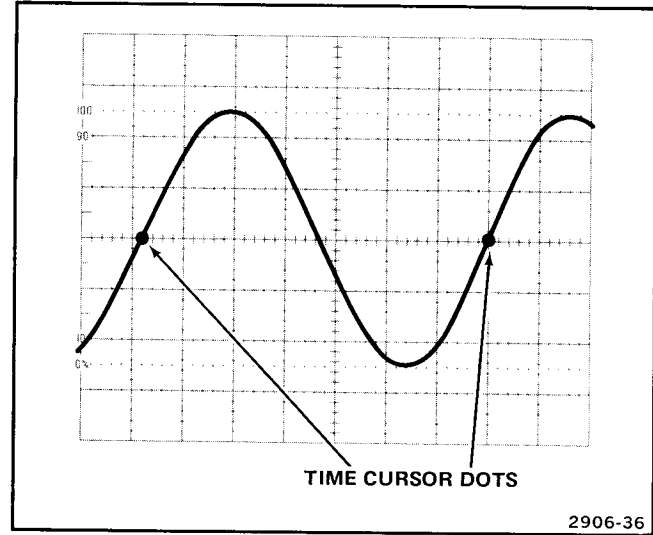

Figure 19. Time duration, cursor method.

FREQUENCY

The frequency of a recurrent signal can be calculated from the time duration of one complete cycle (period).

GPIB Switch Operation

The GPIB switch is located on the 468 rear panel (see Figure 10). It is used for selecting the talk address (MTA) to which the interface will respond and for controlling the TALK ONLY (ton) local message. Section 1 of the switch register is the TALK ONLY switch, and the remaining five sections of the switch select a five-bit binary talk address. Section 2 is the most significant bit of the address, and section 6 is the least significant bit (see Figure 51).

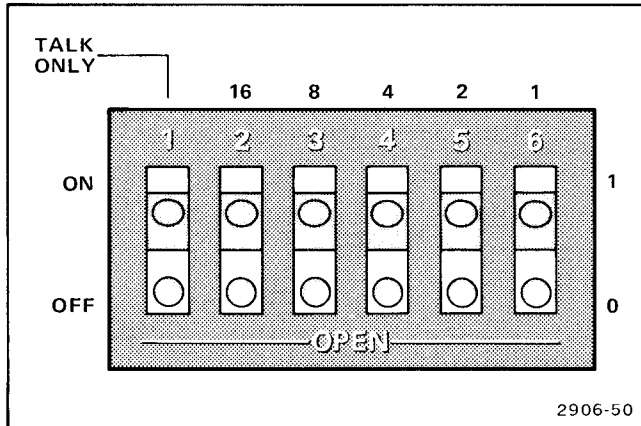

Figure 51. GPIB switch register.

The 468 waveform data transmission can be initiated in two ways: either by pressing the TRANSMIT push button (located on the digital storage right-side panel), or by being under the direction of a bus controller. Either method will cause the waveform to be transmitted, but the sequence of events that occur in the 468 GPIB interface and on the bus depends on the setting of the TALK ONLY switch.

TALK ONLY OFF. With a controller on the bus, the TALK ONLY mode should be OFF. This gives the controller maximum control of bus transactions. In this mode, a possible series of actions that may occur when the operator wants to send a waveform is as follows:

1. The TRANSMIT push button is pressed in.
2. A service request message (SRQ) is sent to the controller, and the 468 interface waits for the controller to respond.
3. The controller may respond by doing a serial poll. (This is optional and would not be required if the 468 were the only instrument on the bus.) A typical serial poll routine would be in the following sequence:

1. Measure the time duration of one period of the waveform using the preceding Time Duration measurement procedure.

2. Using the following formula, calculate the reciprocal of the time duration value to determine the frequency of the waveform:

$$\text{Frequency} = \frac{1}{\text{Time Duration}}$$

EXAMPLE: The time duration of one waveform period is 16.67 milliseconds.

$$\text{Frequency} = \frac{1}{16.67 \times 10^{-3} \text{ s}} = 60 \text{ Hz}$$

RISE TIME

Rise-time measurements use the same methods as time duration, except that the measurements are made between the 10% and 90% points on the leading edge of the waveform. Fall time is measured between the 90% points on the leading edge of the waveform. Fall time is measured between the 90% and 10% points on the waveform trailing edge.

1. Acquire the waveform to be measured in the NORM Storage Mode. Use appropriate STORAGE WINDOW and Trigger SLOPE settings that will display the leading edge of the waveform at the start of the trace. Use a TIME/DIV setting that will display several cycles or events, if possible (see Figure 20).

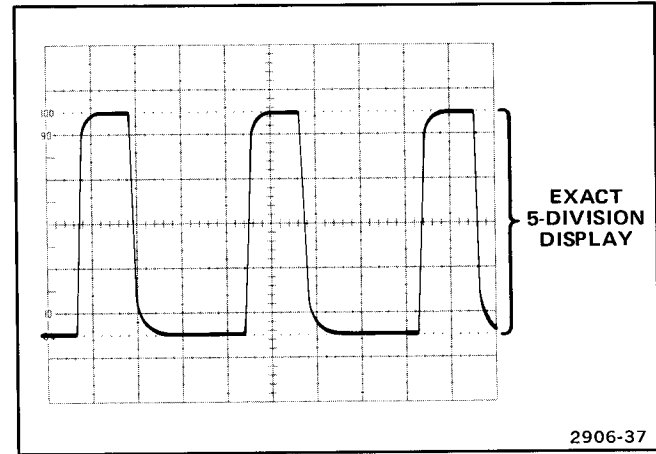

Figure 20. Rise-time setup, five-division display.

2. Set the VOLTS/DIV switch and VOLTS/DIV VAR control (or signal amplitude) for an exact five-division display.

Table 5
INTERFACE COMMANDS

GPIB Message	468 Interface Response
Interface Clear (IFC)	The 468 returns to the serial-poll-idle state (SPIS) and enters the talker-idle state (TIDS). End or Identify (EOI) and new byte available (nba) become unasserted. Talker LED (\overline{TIDS}) goes out, but the service request LED (SRQ) remains on if asserted. The 468 interface then waits for IFC to become unasserted before processing other GPIB traffic, including attention (ATN).
Device Clear (DCL)	<p>If received during transmission of data, the 468 goes to a state of having completed the transmission. The SRQ is unasserted, and the 468 must receive a new My Talk Address (MTA) before it will begin transmitting again.</p> <p>DCL will not clear an SRQ issued by the 468 as part of the power-on routine. To remove the power-on SRQ, the instrument must be made a talker and the status byte sent. This ensures that the controller knows the 468 is powered up on the bus.</p>
Serial Poll Enable (SPE)	The 468 interface enters the serial-poll-mode state (SPMS).
Serial Poll Disable (SPD)	The 468 leaves serial-poll-mode state (SPMS).
My Talk Address (MTA)	Binary address set by the GPIB switch on the 468 rear panel. Bus controller sends MTA to the 468 to obtain its status byte (serial poll) or to start its transmission of waveform data.
Untalk (UNT) or Other Talk Address (OTA)	468 untalks.

3. Use the channel Vertical POSITION control to align the zero reference of the waveform with the 0% graticule marking on the left edge of the graticule lines. Position the top of the waveform to line up with the 100% graticule marking.

4. Set the TIME/DIV switch for a single-event display, with the rise time spread horizontally as much as possible within the viewing area (see Figure 21).

NOTE

The SAVE Storage Mode button may be pressed in at this time to hold the waveform acquired for as long as desired. Voltage and time measurements may be made on the SAVE waveform with less movement of the cursors due to trigger jitter.

5. Select the TIME cursors and use the CURSOR control knob to move the active cursor dot to the intersection of the waveform leading edge and the 10% graticule line.

6. Press in the CURSOR SELECT button to activate the other cursor dot. Use the CURSOR control knob to move

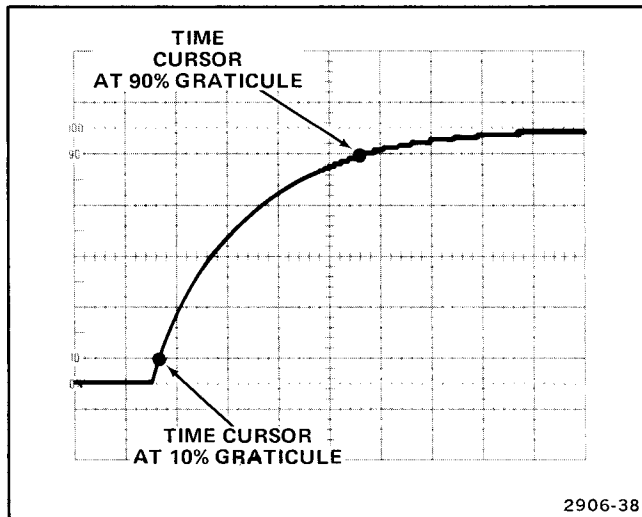

Figure 21. Rise time, cursor method.

the dot to the intersection of the waveform leading edge and the 90% graticule line.

7. Read the pulse rise time from the four-digit, seven-segment LED indicators. Measurement scale factor is indicated by the illuminated LED on the right side of the seven-segment indicators.

Table 4
468 GPIB FUNCTION SUBSETS

Identification	Description	States Omitted	Other Requirements	Other Required Subsets Used
SH1 (Source Handshake)	Complete Capability	None	None	T1
AH1 (Acceptor Handshake)	Complete Capability	None	None	None
T1 (Talker)	Basic Talker, Serial Poll, Talk Only Mode	None	Omit [MLA^(ACDS)]	SH1 and AH1
LO (listener)	No Capability	All	None	None
SR1 (Service Request)	Complete Capability	None	None	T1
RL0 (Remote/Local)	No Capability	All	None	None
PP0 (Parallel Poll)	No Capability	All	None	None
DC2 (Device Clear)	Omit Selective Device Clear	None	Omit [SDC^(LADS)]	AH1
DT0 (Device Trigger)	No Capability	All	None	None
C0 (Controller)	No Capability	All	None	None

WAVEFORM COMPARISON

Repeated comparisons of unknown signals with a reference signal for amplitude, timing, or pulse-shape analysis may be easily and accurately made using the SAVE REF function of the 468 Oscilloscope.

1. Acquire the known reference signal in the NORM Storage Mode (see NORM Storage Mode Display procedure for acquiring a waveform). Use VOLTS/DIV and TIME/DIV switch settings that will display the reference signal with the desired vertical deflection and sweep rate.

2. Press in the SAVE REF button to store the reference waveform. (See Table 3 for a chart of the reference waveform stored with different combinations of Vertical Module and Storage Mode selections.)

3. Acquire the waveform that is to be compared with the reference waveform.

NOTE

The stored reference will remain displayed as long as the SAVE REF button is in. Switching the oscilloscope to NON STORE will remove the stored waveform from the display, but the SAVE REF waveform will remain in the digital storage memory for use upon return to a storage mode. A new reference waveform is acquired when the SAVE REF push button is released and pressed in again.

4. Use the selected channel Vertical POSITION control to overlay the unknown waveform on the reference waveform for making the comparison (see Figure 22). The vertical deflection and sweep rate remain calibrated to allow direct measurement from the graticule, or the VOLTS or TIME cursors may be used to determine voltage or time differences.

5. The NORM Storage Mode display may be positioned horizontally for comparison with the reference signal by using the following procedure.

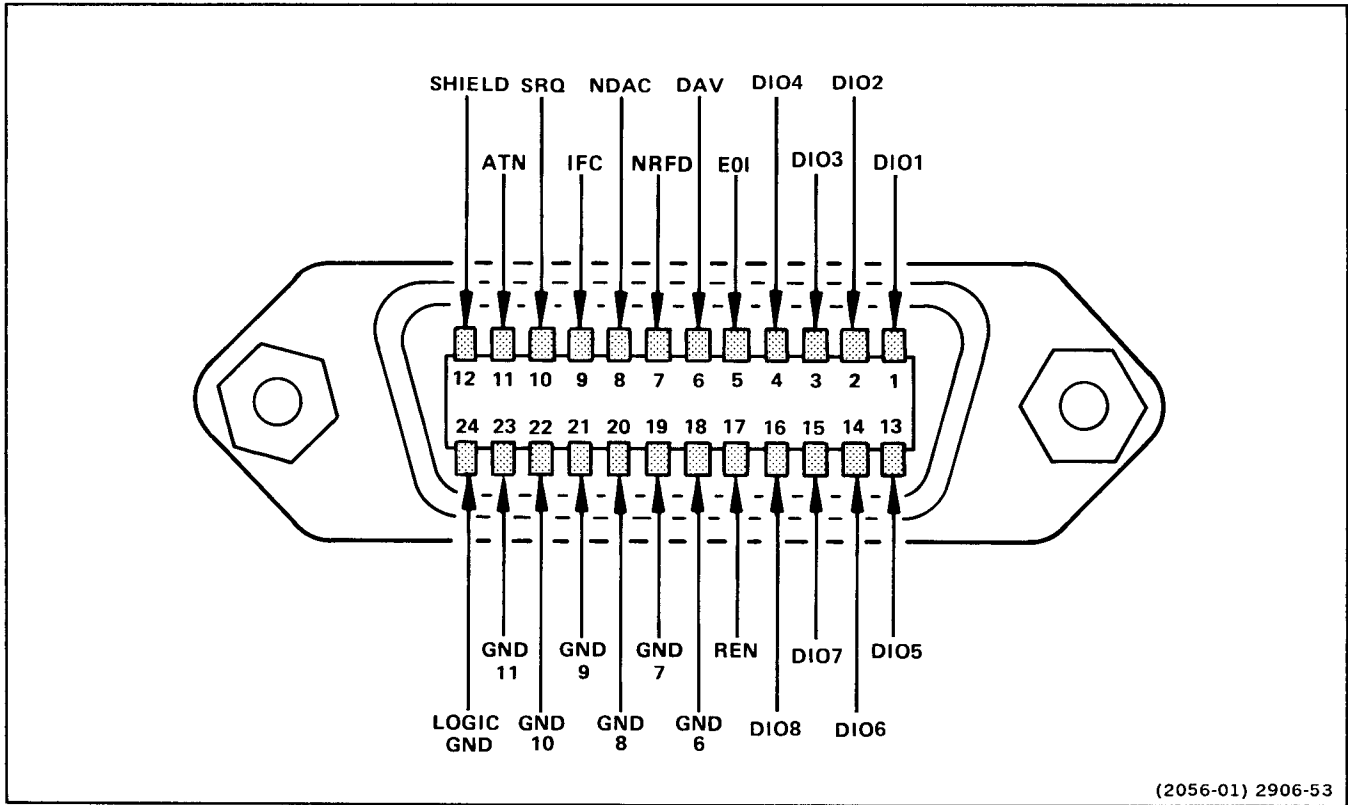

(2056-01) 2906-53

Figure 50. GPIB connector and pin assignments.

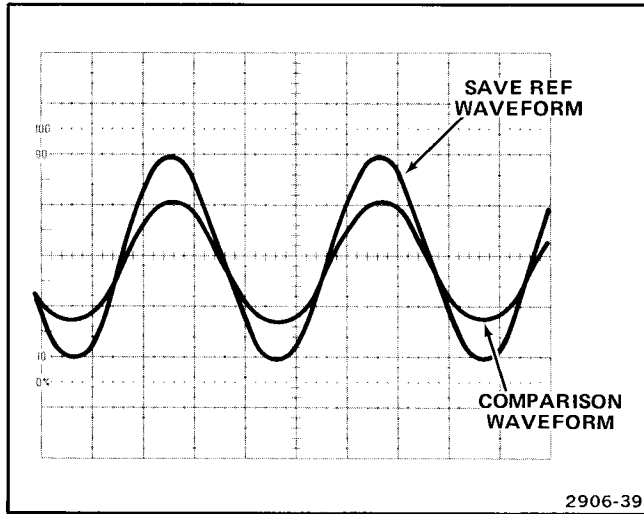

Figure 22. Waveform comparison.

- a. Set B DLY'D Trigger SOURCE to STARTS AFTER DELAY.
- b. Set HORIZ DISPLAY to B DLY'D.
- c. Leave the A and B TIME/DIV knobs locked together and use the DELAY TIME POSITION DIAL to move the NORM Storage mode display horizontally.

TIME DIFFERENCE BETWEEN REPETITIVE PULSES

1. Acquire a NORM Storage Mode display of the signal to be measured. Set the VOLTS/DIV switch to obtain approximately 5 divisions of display amplitude. Use the selected channel Vertical POSITION control to center the display.
2. Set the A TIME/DIV switch to display the points of interest between which the measurement is to be made.
3. Press the SAVE Storage Mode button in to hold the acquired waveform and to provide a more stable display for measurement.
4. Select the TIME cursors and use the CURSOR control knob to position the active cursor on the 50% level of the first pulse leading edge (see Figure 23).
5. Press the CURSOR SELECT knob to activate the other cursor dot and again use the CURSOR control knob to position the active cursor to the 50% level on the leading edge of the second pulse.

message FALSE, only those instruments enabled as a talker and listener(s) can transfer data. Only a controller can generate the ATN signal.

SERVICE REQUEST (SRQ)—Any instrument connected to the bus can request the controller's attention by sending the SRQ message. The controller may respond by executing a serial poll to determine which instrument is requesting service. An instrument requesting service identifies itself by asserting its D107 line TRUE in its status byte. When polled, the instrument requesting service removes the SRQ message.

REMOTE ENABLE (REN)—The system controller sends the REN message TRUE whenever the interface system is operating under remote program control. Used with other control messages, the REN message causes an instrument on the bus to select between two alternate sources of programming data. A remote-local interface function indicates to an instrument that it will receive information input from either the front-panel control (LOCAL) or from the interface (REMOTE). Since the 468 does not have a remote capability, it transmits data as determined by the setting of its front-panel controls.

END OR IDENTIFY (EOI)—A talker can use the EOI message to indicate the end of a data-transfer sequence. The talker sends the EOI message TRUE as the last byte of data is transmitted. In this sense, EOI is essentially a ninth data line and must observe the same setup times as the data bus lines.

GPIB Connector

Physical arrangement of the 24-pin GPIB connector (located on the rear panel of the 468) meets IEEE-488 (1978) GPIB standards. Sixteen pins are assigned to specific signals, and eight to shields and grounds. Voltage and current values required at the connector nodes are based on TTL technology (power source not to exceed +5.5 volts referenced to ground). The logic levels are defined as follows. Logical 1 is a TRUE state, low-voltage level ($\leq +0.8$ V), that is implemented when the signal line is asserted. Logical 0 is a FALSE state, high-voltage level ($\geq +2$ V), that is implemented when the signal line is not asserted. See Figure 50 for an illustration of connector pin assignments and physical arrangement.

Use a standard shielded GPIB cable with all the shields and grounds correctly connected to interconnect the 468 to other instruments on the bus. See the Accessories page at the back of this manual for recommended part number.

Interface Functions and Commands

Since the 468 is a talker only, not all of the interface functions are enabled. Table 4 is a listing of the function subsets, including a description of the 468 capabilities with regard to those subsets. Table 5 is a listing of the interface commands to which the 468 responds, along with a brief description of each response.

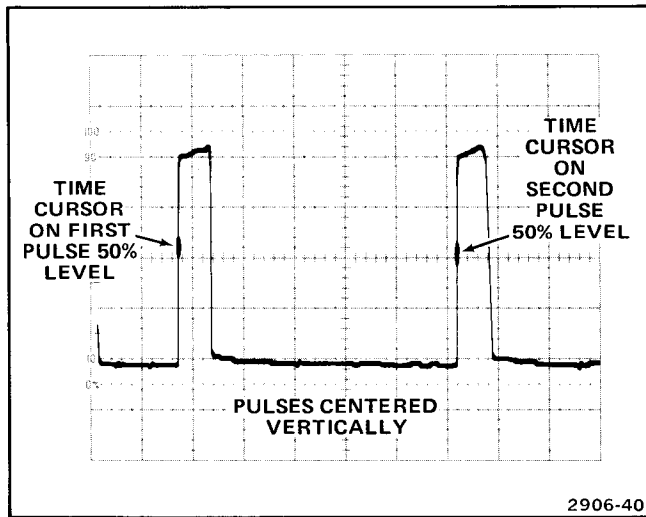

Figure 23. Time difference between repetitive pulses.

NOTE

Pulses with fast rise times have only a few sample points on the leading edge, and it may not be possible to place the cursor dot at exactly the 50% level.

6. Read the time difference between pulses from the four-digit, seven-segment indicators. Measurement scale factor is indicated by the illuminated LED on the right side of the seven-segment indicators.

TIME-DIFFERENCE BETWEEN TWO TIME-RELATED PULSES

1. Select both CH 1 and CH 2 Vertical modes and use probes or coaxial cables with equal time delay to apply the pulse signals to be measured to the input connectors; one to Channel 1 and the second to Channel 2.

2. Set the Channel VOLTS/DIV switches to obtain about three divisions of display amplitude for each signal.

3. Press the NORM Storage Mode button in, set the TRIG MODE switch to NORM, and set the Trigger SOURCE switch to CH 1. Adjust the Trigger LEVEL and SLOPE controls for a continuous, triggered acquisition of the signals.

4. Set the A TIME/DIV switch to obtain a display of the measurement points on the two pulses between which the measurement is to be made.

NOTE

On the GPIB signal lines, the TRUE level is the low voltage amplitude and the FALSE level is the high voltage amplitude.

NOT READY FOR DATA (NRFD)—An asserted (TRUE) NRFD message indicates that one or more assigned listeners are not ready to receive the next data byte from the talker. When all of the assigned listeners for a particular data-byte transfer have released their NRFD, the NRFD message becomes FALSE. This RFD (Ready for Data) message tells the talker it may place the next data byte on the data bus.

DATA VALID (DAV)—The DAV message is asserted TRUE by the talker after the talker places a data byte on the data bus. When TRUE, DAV tells each assigned listener that a new data byte is on the data bus. The talker is inhibited from asserting DAV as long as any listener asserts the NRFD message.

NOT DATA ACCEPTED (NDAC)—Each assigned listener holds the NDAC message asserted TRUE until that listener accepts the data byte currently on the data bus. When all assigned listeners accept the current data byte, the NDAC message becomes FALSE. This DAC (Data Accepted) mes-

sage tells the talker that all assigned listeners have accepted the current data, and the data may be removed from the bus.

When both NDAC and NRFD are FALSE at the same time, an invalid state exists on the bus, indicating that no listener is on the bus.

THE MANAGEMENT BUS. The management bus is a group of five signal lines (IFC, ATN, SRQ, REN, and EOI) which are used to control the operation of the GPIB.

INTERFACE CLEAR (IFC)—The system controller asserts the IFC message TRUE to place all interface circuitry in a predetermined quiescent state (this may or may not be the power-on state). Only the system controller can generate this signal. While IFC is TRUE, no other messages will be recognized.

ATTENTION (ATN)—A controller asserts the ATN message TRUE when instruments connected to the bus are being enabled as either talkers or listeners and when there is other interface-control traffic. As long as the ATN message is TRUE, only instrument address codes and control messages can be transferred over the data bus. With the ATN

5. Ensure that the DISPLAY RESPONSE is set to PULSE if the controlling TIME/DIV switch is set to $1 \mu\text{s}$ per division or faster. Set the STORAGE WINDOW push button as required to obtain the entire pulse display.

6. Press the SAVE Storage Mode button in to save the waveform and to present a more stable display for measurement. The time cursor dots will appear on both the Channel 1 and Channel 2 traces in the SAVE Storage Mode when the TIME Cursor Function button is pressed in.

7. Press the TIME Cursors Function button in and use the CURSOR control knob to position the active cursor dot to the 50% point of the Channel 1 pulse leading edge (see Figure 24).

NOTE

Pulses with fast rise time have only a few sample points on the leading edge, and it may not be possible to place the dot at exactly the 50% level on the leading edge.

8. Press the CURSOR SELECT button once to activate the other cursor dot and use the CURSOR control knob to

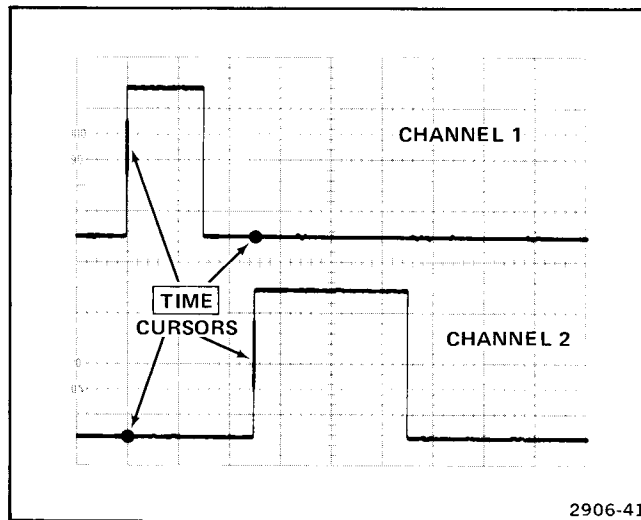

Figure 24. Time difference between two time-related pulses.

position the dot at the 50% level of the Channel 2 pulse leading edge.

9. Read the time difference between the pulses from the four-digit, seven-segment indicators.

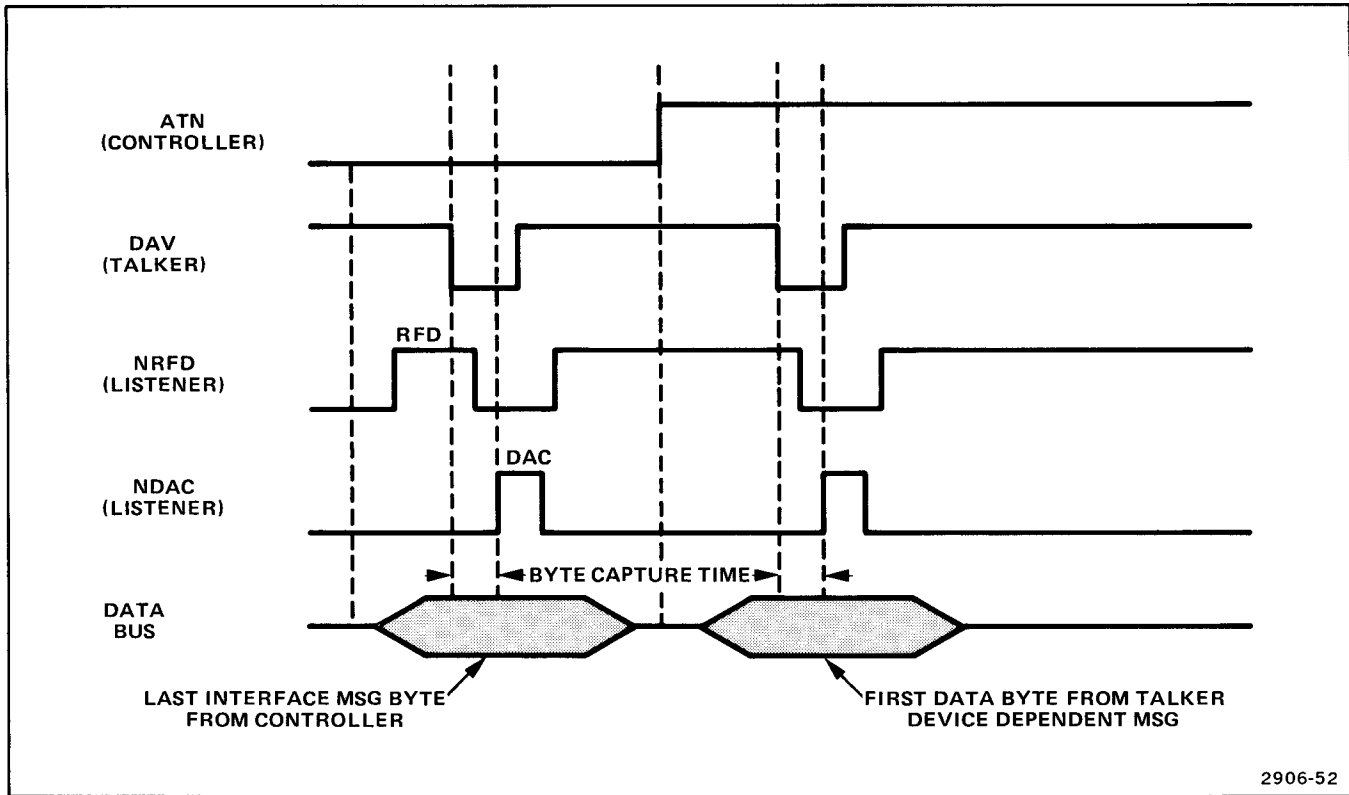

Figure 49. A typical handshake timing sequence (idealized).

PHASE DIFFERENCE BETWEEN SINUSOIDAL SIGNALS

1. Using both probes (provided as standard accessories) or two equal-length coaxial cables, connect the reference signal to the Channel 1 input connector and the other (phase-shifted) signal to the Channel 2 input connector.

2. Press in both the CH 1 and CH 2 VERT MODE push buttons. Use either CHOP (in) or ALT (out) VERT MODE, depending on the input signal frequencies. In general, ALT is best for TIME/DIV switch settings faster than 1 ms per division, and CHOP is more suitable for TIME/DIV switch settings slower than 1 ms per division.

3. Obtain a Normal Sweep Display of the two input signals.

4. Set the Trigger SOURCE switch to CH 1 and adjust the A Trigger LEVEL control and A Trigger SLOPE control for a stable, triggered display.

5. Use a TIME/DIV switch setting that displays about two cycles of each input signal.

6. Press in the NORM Storage Mode push button.

7. Check that the A Trigger LEVEL control is adjusted for a stable, triggered acquisition.

NOTE

Use the NORM Trigger Mode for low-repetition-rate signals (below approximately 20 Hz). This ensures that the storage window and trigger signal are synchronized when the trace is triggered.

8. Set both VOLTS/DIV switches and adjust the VOLTS/DIV VAR controls to obtain a 5-division vertical display of each input signal.

NOTE

Use the channel Vertical POSITION controls in conjunction with the VOLTS/DIV VAR controls to vertically center the 5-division display between the 0% and 100% dotted reference graticule lines.

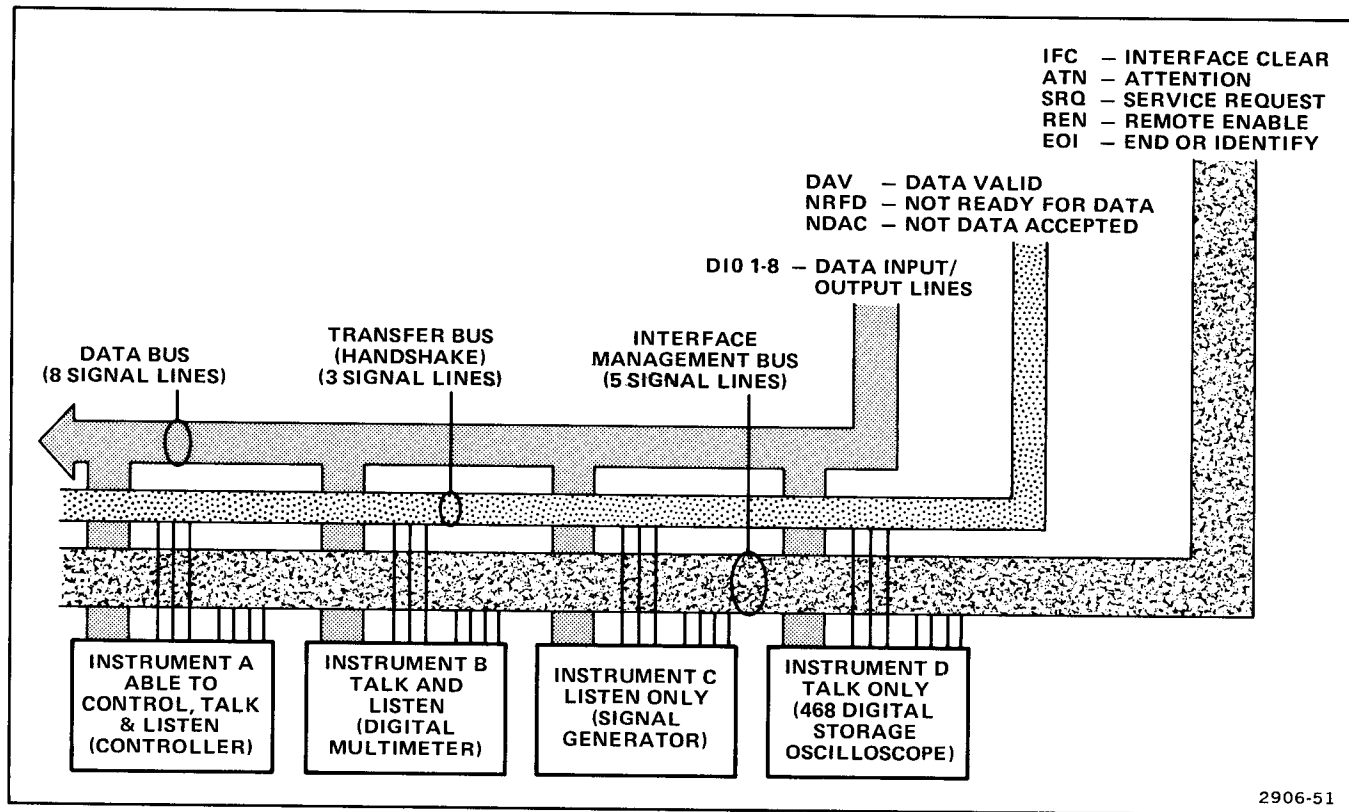

Figure 48. A typical system using the general purpose interface bus (GPIB).

9. Select PRE TRIG or POST TRIG Storage Window and the A Trigger SLOPE (+ or -) as necessary to place the measurement points within the graticule area (see Figure 25A).

10. Press in the TIME Cursor Function push button. Two bright cursor dots will appear on the Channel 1 reference signal trace. Adjust the INTENSITY control as necessary to make the dots distinguishable from the trace.

11. Use the CURSOR control knob to position the active cursor to the sine wave's first zero-crossover point (center horizontal graticule line).

12. Press the CURSOR SELECT Push button once to activate the second time-cursor dot and use the CURSOR control knob to position the active cursor to the sine wave's third zero-crossover point (360°).

13. Note the time of the sine-wave period (T_1) from the seven-segment LED display. The scale factor is indicated by the illuminated LED to the right of the seven-segment display.

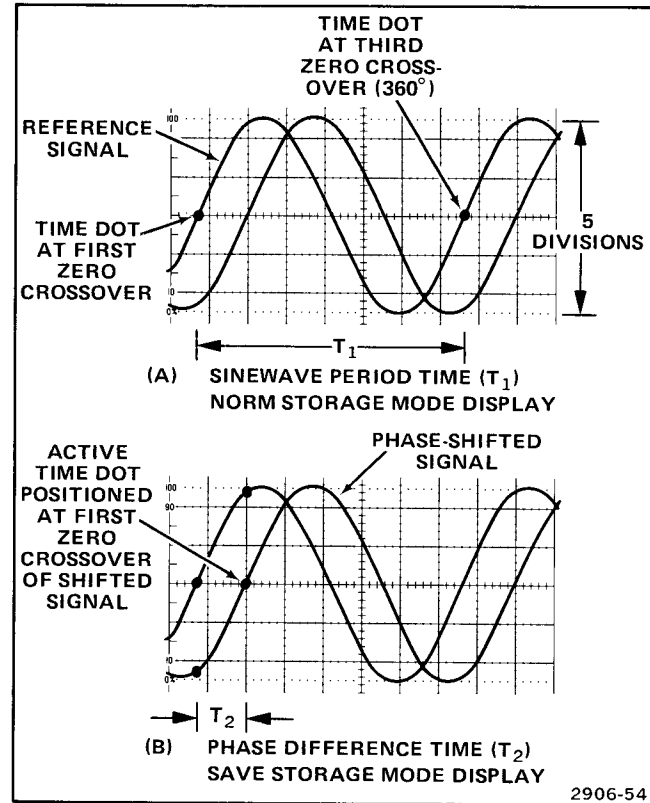

Figure 25. Phase difference between sinusoidal signals.

Controllers, Talkers, and Listeners

A talker is an instrument that can send data over the bus, while a listener is an instrument that can accept data from the bus. No instrument can communicate until it is enabled by the controller in charge of the bus. The 468 is a talker only. By setting the TALK ONLY switch (located on the 468 back panel) to the TALK ONLY position, it can be set up to operate as a talker without needing a controller on the bus. This setup is used when the 468 is in a system that has only listeners on the bus.

A controller is an instrument that determines which of the other instruments on a bus will talk and which instruments will listen during any given time interval. The controller also has the ability to assign itself as either a talker or a listener, whenever the program routine requires. In addition to designating the current talker and listeners for a particular communication sequence, the controller has the task of sending special codes and commands (called interface messages) to any or all of the instruments on the bus.

GPIB Signal Line Definitions

Figure 48 shows the 16 signal lines of the GPIB functionally divided into three component busses: an eight-line data transfer bus, a three-line transfer control (handshake) bus, and a five-wire management bus.

THE DATA BUS. The data bus has eight bidirectional signal lines, D101 through D108. Information, in the form of data bytes, is transferred over this bus. A handshake sequence between an enabled talker and the enabled listeners transfers one data byte (eight parallel bits) as a time. Data bytes in either an interface or device-dependent message are sent in a byte-serial, bit-parallel fashion over the data bus.

Since the GPIB handshake sequence is an asynchronous operation, the data transfer rate at any one time is only as fast as the slowest instrument involved in the data-byte transfer. A talker cannot place data bytes on the bus faster than any one listener can accept them.

THE TRANSFER BUS (HANDSHAKE). Each time a data byte is sent over the data bus, an enabled talker and all enabled listeners execute a handshake sequence via the transfer bus. A typical handshake routine showing the activity on the transfer-bus signal lines is illustrated in Figure 49. The attention (ATN) line is also shown to illustrate the controller's role in the process.

14. Press in the SAVE Storage Mode push button. The TIME cursor dots will now be present on both sine waves (see Figure 25B).

15. Use the CURSOR control knob to position the active cursor to the first zero-crossover point of the phase-shifted signal.

16. Note the phase-difference time (T_2) from the seven-segment LED indicators.

17. The amount of phase shift in degrees is calculated from the following formula:

$$\text{Phase Shift (degrees)} = \frac{T_2}{T_1} \times 360^\circ$$

Example: The period (T_1) of the reference signal shown in Figure 25 is 34.8 ms, and the phase difference time (T_2) is 6.3 ms.

Substituting these values into the equation:

$$\text{Phase Shift} = \frac{6.3 \times 10^{-3} \text{ s}}{34.8 \times 10^{-3} \text{ s}} \times 360^\circ = 65.17^\circ$$

SLOPE

The slope of a particular portion of a waveform is the rate of change of voltage with respect to time. The COUPLED V/T measurement mode is useful for making the measurements required for determining the slope of a portion of waveform.

1. Obtain a NORM Storage Mode display of the waveform to be measured. Set the VOLTS/DIV switch to obtain about 5 divisions of vertical amplitude. Set the TIME/DIV switch to horizontally spread the portion of the waveform to be measured across the width of the graticule area (see Figure 26).

2. Press the SAVE Storage Mode button in to hold the acquired waveform and to provide a more stable display for measurement.

3. Select the COUPLED V/T measurement mode by pressing in both the VOLTS and TIME Cursor Function push buttons.

4. Use the CURSOR control knob to move the coupled active cursors to the first point of interest.

Option 12 (Standard SN B032430 and up)

This option will enable the 468 digital storage circuitry to average the input signal for a selected number of sweeps. The displayed waveform will be updated at the end of each averaging cycle, and then the cycle will be repeated. Acquisition of low-amplitude waveforms is greatly enhanced by the noise cancellation that occurs in the averaging process.

Operating instructions for Option 12 have been incorporated in the basic instrument operating instructions contained in this manual.

OPTION 02 OPERATING INFORMATION

The GPIB is a digital interface that allows efficient communication between the components of an instrumentation system. It is used for transmitting and receiving data between self-contained instruments or devices and acts as an interface system that is independent of device functions.

If the 468 is to be used primarily without a GPIB hook-up, refer the instrument to qualified service personnel to disable the GPIB interface by preventing the TRANSMIT button from being active. Conversely, if the 468 is to be connected

into a bus and its GPIB interface is disabled, pressing the TRANSMIT button will not cause a waveform to be transmitted. When the GPIB option is disabled, the $\overline{\text{TIDS}}/\text{SRQ}$ indicator LED will not illuminate red during power on (to indicate that a service request has been issued). To enable the 468 for GPIB interface operation, refer the instrument to qualified service personnel.

A Typical System on the GPIB

Figure 48 illustrates a typical system using the GPIB and shows the nomenclature established for the 16 active signal lines. While only four instruments are shown, the GPIB can support up to 15 independent devices connected directly to the bus. It is possible, however, to interface more than 15 instruments to a single bus. This is accomplished by connecting several instruments to a primary device, and then connecting only the primary device to the bus. Such a scheme can be used for programmable plug-in units housed in a mainframe. In this configuration the mainframe can be addressed with a primary address code, and the plug-in units can be addressed with a secondary address code.

Instruments connected to a single bus cannot be physically separated by more than 20 meters (total cable length), and at least one more than half the number of instruments on a bus must be in the power-on state. To maintain the electrical characteristics of the bus, one device load must be connected for each two meters of cable length.

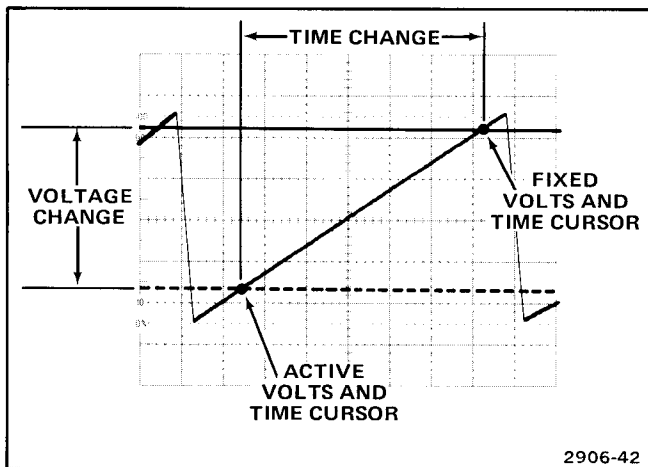

Figure 26. Slope using COUPLED V/T cursors.

5. Press the CURSOR SELECT button to activate the other coupled cursors. Use the CURSOR control knob to move the other coupled cursors to the second point of interest.

6. Read the voltage difference between cursors from the four-digit, seven-segment indicators. Voltage scale factor is indicated by the red illuminated LED on the right side of the seven-segment indicators.

7. Press the TIME Cursor Function push button to release the COUPLED V/T mode and read the time difference between the two measurement points from the four-digit, seven-segment indicators. The time scale factor is indicated by the green illuminated LED on the right side of the seven-segment indicators.

8. Slope is determined by using the measured voltage and time to calculate the rate of change using the following formula:

$$\text{Slope (rate of change)} = \frac{\text{Change in voltage}}{\text{Change in time}}$$

As an example, in Figure 26, the voltage difference between the measurement points is 1.74 V, and the time difference is 5.42 s.

Substituting these values into the formula:

$$\text{Slope} = \frac{1.74 \text{ V}}{5.42 \text{ s}} = 0.32 \text{ V/s}$$

LOW-LEVEL SIGNAL MEASUREMENTS

Digital storage has the capability to vertically expand the display of a signal acquired at 5 mV per division up to 10 times by using the 2, 1, or 0.5 mV per division positions of the VOLTS/DIV switch. Figure 27 is an illustration of a 1 mV

OPTIONS

Your 468 may be equipped with one or more instrument options. A brief description of each option is given in the following discussion. Detailed operating information pertaining to the options is presented on succeeding pages of this section. For further information on instrument options, see your Tektronix Catalog or contact your Tektronix Field Office or representative.

NOTE

The 468 oscilloscope cannot be equipped with both Option 02 and Option 11 due to use of common space.

GENERAL DESCRIPTION

Option 02

When equipped with this option, the 468 has the capability to transmit a waveform message on a GPIB (General Purpose Interface Bus). During a transmission, the last waveform acquired by the 468 will be sent to either a bus controller or a listener instrument. The waveform message format will conform to the Waveform Transmission Standard as specified in the Tektronix Standard-General Purpose Interface Bus (GPIB), Codes and Formats (Rev. C).

NOTE

If the 468 is to be used without a GPIB hookup, the GPIB option can be internally disabled. Once disabled, it will be necessary for qualified service personnel to enable the GPIB option before connecting the 468 to a GPIB system.

Option 04

The instrument is modified to meet certain specification requirements related to conducted and radiated electromagnetic interference. This option does not affect the basic instrument operating instructions presented in this manual.

Option 05

This option provides the instrument with front-panel selection of additional trigger-signal processing capabilities to facilitate observation and measurement of composite video and related television waveforms.

Option 11

This option enables the 468 to convert the digital data stored in memory into analog X and Y outputs for driving an X-Y Plotter. Because the operation is largely automatic, only a few switch settings are required.

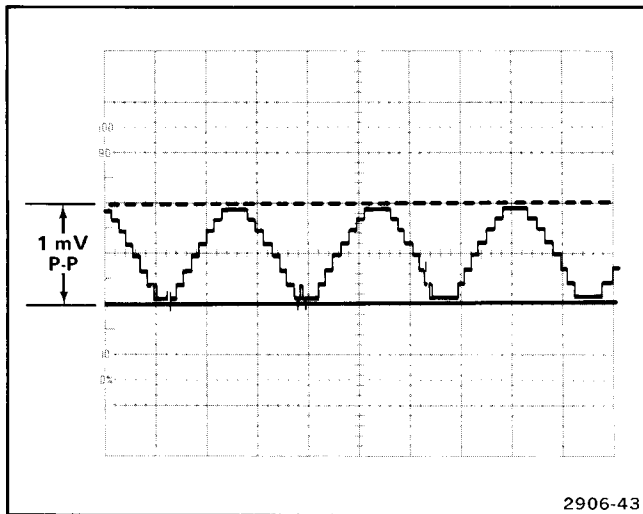

Figure 27. Low-level signal, NORM Storage Mode.

peak-to-peak signal being displayed at 0.5 mV per division. The stair-step pattern is due to the small changes of signal applied to the digitizing circuitry when the NORM Storage Mode is used to acquire the waveform. The numerous spikes in the waveform are due to the noise accompanying the signal.

The AVG Storage Mode may be used to reduce, or even eliminate, the noise displayed with the averaged signal. Even though the signal-level changes applied to the digitizing circuitry are small, processing of the added averaged waveform data results in a smooth display of the signal.

Figure 28 is an illustration of the same signal level as displayed in Figure 27, but the waveform was averaged 32 times before being displayed. Low-level signals can be acquired in the same manner as explained in previous acquisition procedures. External triggering may be helpful for producing a stable display if the amplitude of the signal being acquired is very low. All measurement procedures described in the preceding part of this manual are also valid for low-level signals.

EXPANSION OF NORM STORAGE DISPLAYS

When increasing sweep speeds with the A and B TIME/DIV switches, slightly different procedures must be followed between PRE TRIG and POST TRIG Storage Window. In storage, expansion does not take place from the beginning of the trace as it does in nonstorage. From 5 s to 2 μ s per division, the pretrigger trace expansion point is data point 448 (approximately 8.3 horizontal graticule divi-

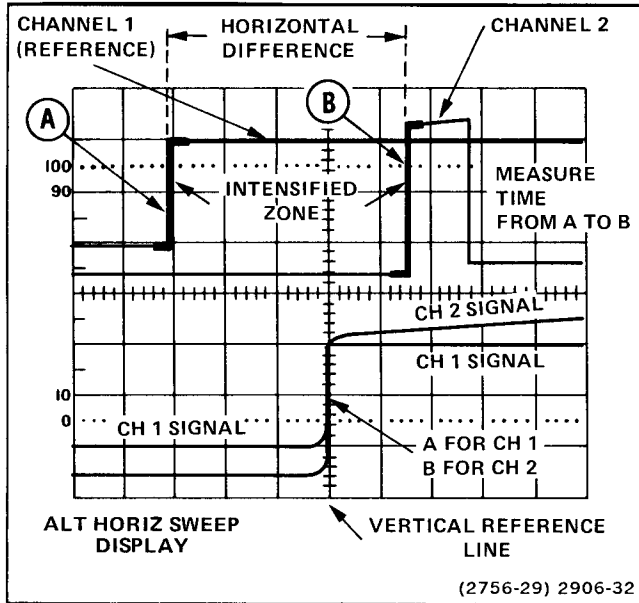

Figure 47. Time difference between two time-related pulses, ALT HORIZ DISPLAY.

11. Record the DELAY TIME POSITION control dial setting.

12. Calculate the time difference between the Channel 1 and Channel 2 pulses as in the preceding "Time Duration" measurement procedure.

EXAMPLE: With the A TIME/DIV switch set to $50 \mu\text{s}$, the dial reading for the reference pulse (Channel 1) is 2.60 and the dial reading for the comparison pulse (Channel 2) is 7.10.

Substituting the given values into the time difference (or duration) formula:

$$\text{Time Difference} = (7.10 - 2.60) (50 \mu\text{s}) = 225 \mu\text{s}$$

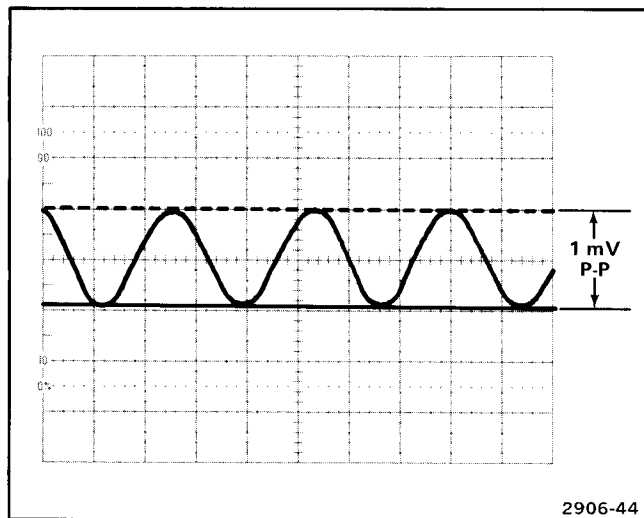

Figure 28. Low-level signal, averaged 32 times.

sions). For the post-trigger trace, expansion occurs at data point 64 (approximately 1.3 horizontal graticule divisions). At sweep speeds from $1 \mu\text{s}$ to $0.02 \mu\text{s}$ per division, data for both pretrigger and post trigger is expanded horizontally in both directions from data point 64.

NOTE

For chopped signal acquisition, the trigger is located at data point 32.

The portion of a B DLY'D Horizontal Display that is positionable using the DELAY TIME POSITION control also differs between pretrigger and post trigger. Starting with the DELAY TIME POSITION control fully counterclockwise and rotating it clockwise, the trigger point of the pretrigger display may be positioned to the left 8.3 divisions before going out of the graticule area. The post-trigger display may be positioned only 1.3 divisions to the left before going off the graticule area. Therefore, when using B DLY'D, a PRE TRIG Storage Window allows the operator to view and position data points occurring after the trigger.

PRE TRIG Storage Window

To hold the PRE TRIG Storage Window trigger point within the graticule area when using sweep speeds faster than $2 \mu\text{s}$ per division:

1. Set:

HORIZ DISPLAY	B DLY'D
TIME/DIV (both)	$2 \mu\text{s}$
A Trigger COUPLING	AC
A Trigger LEVEL	Stable display
B Trigger SOURCE	STARTS AFTER
	DELAY
DELAY TIME POSITION	Fully ccw

$$\text{Time Difference} = (8.31 - 1.31) (0.2 \mu\text{s}) = 1.4 \mu\text{s}$$

Time Difference Between Two Time-Related Pulses

1. Obtain a Normal Sweep Display. Ensure that the TIME/DIV VAR control is in the calibrated detent.
2. Set the A Trigger SOURCE switch to CH 1.
3. Using probes or cables having equal time delays, connect the reference signal to the Channel 1 input and connect the comparison signal to the Channel 2 input.
4. Press in both the CH 1 and CH 2 VERT MODE push button. Use either CHOP (in) or ALT (out) Vertical Mode to display the signals, depending on the frequency of the input signals. In general, CHOP is more suitable for low-frequency signals, and ALT is best for high-frequency signals.
5. Press in the A INTEN HORIZ DISPLAY push button and ensure that the B Trigger SOURCE switch is set to STARTS AFTER DELAY. Set the B TIME/DIV switch to obtain the smallest usable intensified zone.

6. Press in the ALT HORIZ DISPLAY push button and release the CH 2 VERT MODE push button. Adjust Channel 1 POSITION and TRACE SEP controls so that the A trace and B trace are displayed one above the other.

7. Rotate the DELAY TIME POSITION control to move the intensified zone to the rising edge of the reference pulse (on the A trace) and then fine adjust until the rising portion (on the B trace) is centered at any convenient vertical graticule line (see Figure 47, point A).

8. Record the DELAY TIME POSITION control dial setting.

9. Press in the CH 2 VERT MODE push button and release the CH 1 VERT MODE push button. Adjust the Channel 2 POSITION control and the TRACE SEP control as necessary to display the Channel 2 A trace over the B trace.

10. Rotate the DELAY TIME POSITION control to set the the rising portion of the Channel 2 pulse (in the B trace) to the same vertical reference point as the Channel 1 pulse (see Figure 47, point B). Observe the A trace to position the intensified zone to the correct pulse (if more than one pulse is displayed). Do not change the setting of the Horizontal POSITION control.

2. Rotate the DELAY TIME POSITION control clockwise to set the pretrigger trigger point of the waveform to approximately 1.3 horizontal divisions from the left edge of the graticule.

3. Pull the B TIME/DIV knob to unlock it from the A TIME/DIV knob.

4. Expand the waveform by setting the B TIME/DIV knob to sweep speeds faster than $2 \mu\text{s}$ per division. Use the DELAY TIME POSITION control to hold the trigger point at approximately 1.3 horizontal graticule divisions.

POST TRIG Storage Window

For POST TRIG expansion, the trigger point is the 64th data point both above and below sweep speeds of $2 \mu\text{s}$ per division. To hold the POST TRIG Storage Window trigger point within the graticule area when using B DLY'D Horizontal Display:

1. Set the DELAY TIME POSITION control fully counterclockwise.

2. Expand the waveform (or reduce the waveform) using the A and B TIME/DIV knobs locked together.

NOTE

If using HF REJ Trigger Coupling on pulse input trigger signals, the Trigger LEVEL control will have considerable range in controlling the trigger point, and thus the position of the trigger point on the trace.

ENVELOPE STORAGE MODE

Anti-Aliasing

In digital sampling, the accuracy of the reproduced waveform, when displayed, is directly proportional to the number of samples obtained during one full cycle of the signal. That is, a more accurate reproduction of a signal is possible when more samples of the signal are obtained. The 468 will sample 500 times across the full 10 horizontal divisions of the graticule when in the NORM Storage Mode. This means that a sine wave spread across the full screen will be sampled 500 times, but if the sine wave is only one graticule division in width, it will be sampled one-tenth as many times (50 samples). This number is still adequate for accurate reproduction of the stored waveform.

Now carry this further. If the TIME/DIV switch is set so that the entire sine-wave period fills one-tenth of a graticule division, it will be sampled only five times during its acquisition. This means that only five samples of the waveform will be available to reproduce the waveform for display. In the-

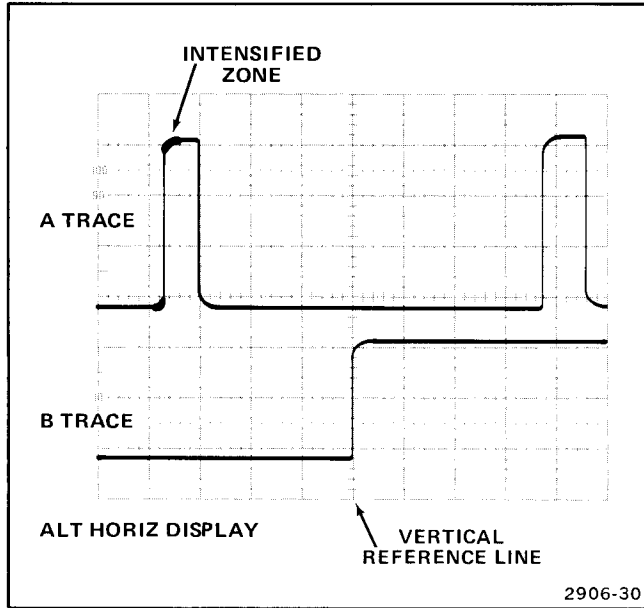

Figure 46. Time difference between repetitive pulses.

INTENSITY and B INTENSITY controls as required to obtain the desired intensified zone and B trace brightness.

7. Observe the B trace display and adjust the DELAY TIME POSITION control to move the rising portion of its pulse to the vertical reference line (see Figure 46).

8. Record the DELAY TIME POSITION control dial setting.

9. Rotate the DELAY TIME POSITION control clockwise to move the rising portion of the second pulse to the vertical reference line. Observe the A trace display to position the intensified zone to the correct pulse. Do not change the setting of the Horizontal POSITION control.

10. Record the DELAY TIME POSITION control dial setting.

11. Calculate the time difference as in the preceding "Time Duration" procedure.

EXAMPLE: For the pulses illustrated in Figure 46, the first dial setting is 1.31 and the second dial setting is 8.81, with the A TIME/DIV switch set to $0.2 \mu\text{s}$.

Substituting the given values into the time difference (or duration) formula:

ory, if a sine wave is sampled at least two times during its period, it may be accurately reproduced. In practice, the sine wave can be reconstructed, using special filters, from slightly more than two samples.

The 468 NORM Storage Mode has an analog bandwidth of 10 MHz and a maximum sampling rate of 25 MHz. Consequently, a signal at the upper frequency limit will be sampled a maximum of 2.5 times during the complete sine-wave period (five times for two periods), and the waveform will be accurately reproduced.

If the input frequency is increased beyond 10 MHz, the samples will soon become less than two times per period. This occurs at 12.5 MHz for a 25 MHz sample rate. Past this point, information sampled from two different sine-wave periods will be used to reconstruct the displayed waveform. Obviously, this waveform cannot be a correct reproduction of the input signal. At certain input frequencies the data sampled will reproduce what appears to be a correct display, when in fact it is only related to the input signal by some multiple or part of a multiple of the input signal. This display is called an "alias" (see Figure 29A).

The example given is for the maximum sampling rate of 25 MHz. However, the sampling rate is controlled by the

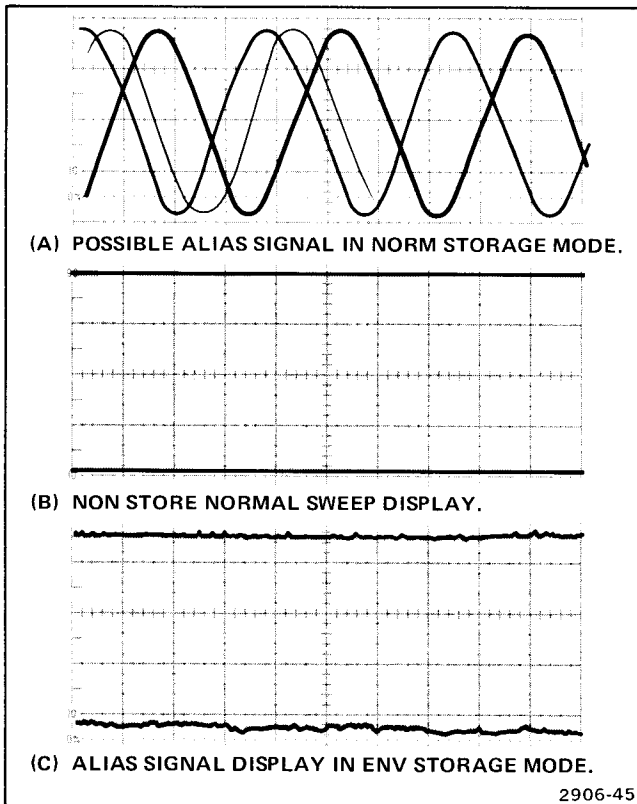

Figure 29. Anti-aliasing.

6. Rotate the DELAY TIME POSITION control to move the start of the intensified zone (left-hand edge) until it just touches the intersection of the signal and the 10% graticule line (see Figure 45, point A).

7. Record the DELAY TIME POSITION control dial setting.

8. Rotate the DELAY TIME POSITION control to move the start of the intensified zone (left-hand edge) until it just touches the intersection of the signal and the 90% graticule line (see Figure 45, point B).

9. Record the DELAY TIME POSITION control dial setting.

10. Calculate the time difference (rise time) as in the preceding "Time Duration" measurement procedure.

EXAMPLE: With the A TIME/DIV switch set to $1 \mu\text{s}$, the DELAY TIME POSITION dial setting at point A is 2.50 and the DELAY TIME POSITION dial setting at point B is 7.50.

Substituting the given values in the formula:

$$\text{Rise Time} = (7.50 - 2.50) (1 \mu\text{s}) = 5 \mu\text{s}$$

Time Difference Between Repetitive Pulses

1. Obtain a Normal Sweep Display of the signal to be measured.

2. Set the A TIME/DIV switch to display the measurements points of interest within the graticule area.

3. Press in the ALT HORIZ DISPLAY push button and set the B Trigger SOURCE switch to STARTS AFTER DELAY.

4. For the most accurate measurement, set the B TIME/DIV switch to the fastest sweep that provides a usable (visible) intensified zone.

5. Rotate the DELAY TIME POSITION control to move the intensified zone to the first pulse (see Figure 46).

6. Adjust the Vertical POSITION and TRACE SEP controls to display the A trace above the B trace. Adjust the

TIME/DIV switch, and whenever it is set so that the input signal is sampled less than two times per period, an alias can occur.

In the event that an alias is suspected, two things may be done to determine whether the display is of an alias. The first is to switch back to NON STORE Mode to determine if the input signal is higher in frequency than the apparent signal being displayed (see Figure 29B). (Ensure that this display is being triggered as indicated by the TRIG LED being illuminated.) The second is to use the ENVELOPE Storage Mode, which holds all the maximum, and minimum points being acquired in an accumulative display. Since the maximum and minimum points of the alias waveform do not occur at exactly the same data point each time, the display soon acquires maximum and minimum amplitude levels in every storage address, and the top and bottom of the alias envelope display become flat lines. (See Figure 29C.)

If an alias is detected, the TIME/DIV switch may be set for a faster sweep rate so that the number of samples per cycle of the input signal is increased. However, at sweep speeds of 1 μ s per division and faster, the sampling rate is not increased, and if an alias signal is still present at 2 μ s per division, the frequency limit of the digital circuitry has been exceeded.

For frequencies below 10 MHz, the ENVELOPE Storage Mode can be used to determine the amplitude of the alias, but the *frequency* information displayed by an alias is not valid. For frequencies beyond 10 MHz, the digital storage bandwidth rolls off, and the *amplitude* of an alias display is not a valid representation.

Glitch Catching

Pulses that are present for a very short time duration during the viewing of longer pulse duration signals, such as a logic pulse train, may not be visible at the sweep speed in use (see Figure 30A). In digital logic circuitry, a small switching transient (glitch) may cross the logic threshold level and cause an error. Setting up the 468 to trigger on the error event should position the storage window to acquire the pulse train that contains the glitch.

To catch a glitch, first select PRE TRIG Storage Window. This will acquire 7/8 of a waveform occurring before the trigger. Press the ENVELOPE Storage Mode button in to acquire the waveform maximum and minimum points over a selected number of sweeps (default number of 32 is a good choice). The location of the glitch will be displayed in the accumulative envelope display (see Figure 30B).

Rise Time

Rise time measurements use the same methods as for time duration, except that the measurements are made between the 10% and 90% points on the leading edge of the waveform. Fall time is measured between the 90% and 10% points on the trailing edge of the waveform.

1. Obtain a Normal Sweep Display. Ensure that the TIME/DIV VAR control is in the calibrated detent and use a sweep speed setting that displays one or two complete cycles or events, if possible.

2. Set the appropriate VOLTS/DIV switch and the VOLTS/DIV VAR control (or signal amplitude) for an exact five-division vertical display.

3. Vertically position the trace so that the zero reference of the waveform touches the 0% graticule line and the top of the waveform touches the 100% graticule line (see Figure 45).

4. Set the A TIME/DIV switch for a single-event display, with the rise time spread horizontally as much as possible. Horizontally position the display so the 10% point of the

waveform intersects the third vertical graticule line (see Figure 45).

5. Press the A INTEN HORIZ DISPLAY push button in. Set the B Trigger SOURCE switch to STARTS AFTER DELAY. Set the B TIME/DIV switch to the fastest sweep speed that provides a usable (visible) intensified zone.

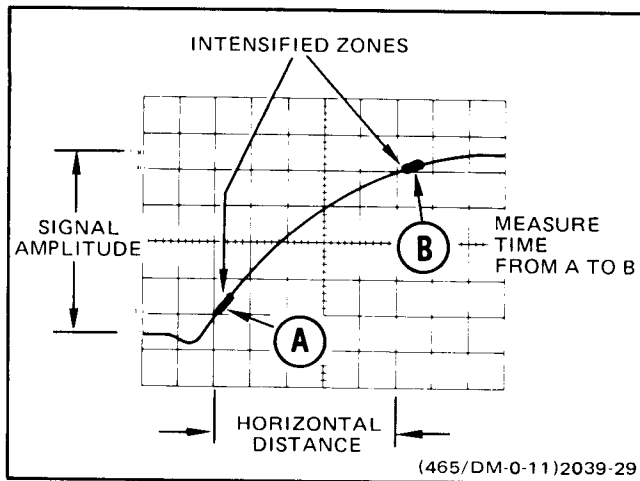

Figure 45. Rise time, differential time method.

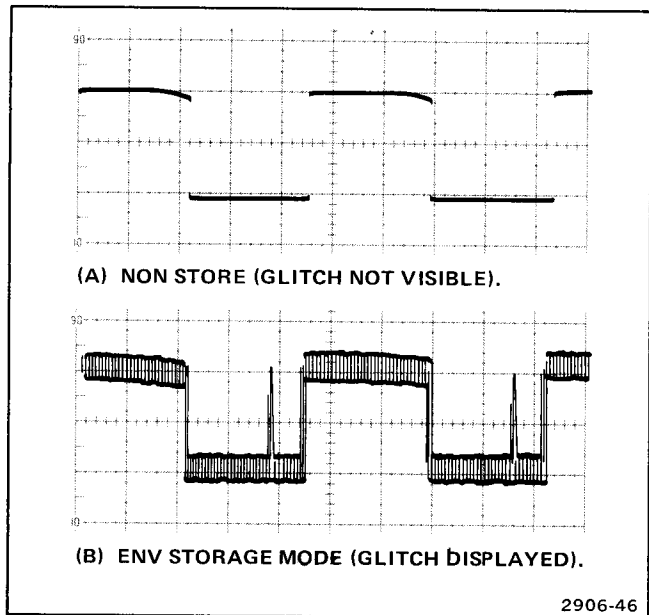

Figure 30. Glitch display, ENVELOPE Storage Mode.

Glitch Measurement

Once a glitch has been observed, you may wish to obtain measurements of amplitude and pulse width. The following

procedure may be used to acquire the glitch in the NORM Storage Mode using delayed sweep. By selecting appropriate trigger sources, the procedure may be used for any similar waveform situation (i.e., selecting triggers that set up a storage window containing the pulse, or glitch, to be acquired).

To view the glitch in the pulse train for measurement purposes:

1. Preset the 468 controls for obtaining a Normal Sweep Display, with the following exceptions:

TRIG MODE	NORM
A Trigger SOURCE	EXT (error event)
B Trigger SOURCE	Selected channel
HORIZ DISPLAY	B DLY'D
NON STORE	Push button in

2. Adjust the A Trigger SLOPE and LEVEL controls for a stable display of the A trace. Set the B Trigger SLOPE to either + (plus) for positive pulses or - (minus) for negative pulses. Adjust the B Trigger LEVEL control for a stable intensified zone. Adjust the INTENSITY and B INTENSITY controls as necessary to make the intensified zone distinguishable from the A trace.

6. Rotate the DELAY TIME POSITION control to move the start of the intensified zone to the second time-measurement point (see Figure 43, point B).

7. Record the DELAY TIME POSITION control dial setting.

8. Determine the time difference using the following formula:

$$\text{Time Difference (or Duration)} = \left(\begin{array}{cc} \text{Second dial} & \text{First dial} \\ \text{reading} & \text{reading} \end{array} - \right) \left(\begin{array}{c} \text{A TIME/DIV} \\ \text{switch} \\ \text{setting} \end{array} \right)$$

EXAMPLE: With A TIME/DIV switch set to 2 ms, the DELAY TIME POSITION dial setting at point A is 1.20 and the DELAY TIME POSITION dial setting at point B is 9.53 (see Figure 44).

Substituting the given values:

$$\text{Time Duration} = (9.53 - 1.20) (2 \text{ ms}) = 16.66 \text{ ms}$$

Frequency

The frequency of a recurrent signal is determined by computing the reciprocal of the time duration of one complete cycle.

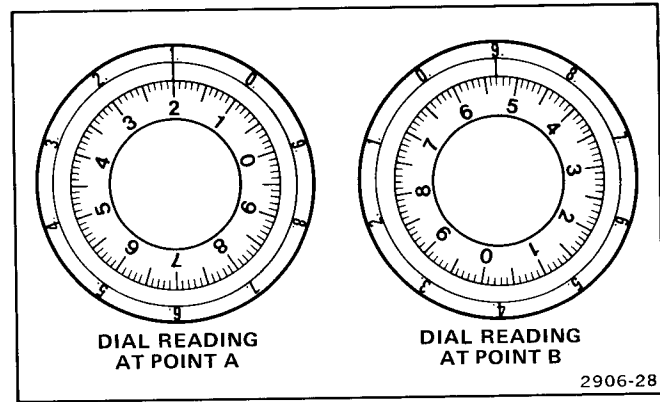

Figure 44. DELAY TIME POSITION control settings for time duration measurement example.

EXAMPLE: The time duration for one cycle (Figure 43, point A to point B) is 16.66 ms.

Using the formula and substituting the given values:

$$\text{Frequency} = \frac{1}{\text{Time Duration}} = \frac{1}{16.66 \text{ ms}} = 60 \text{ Hz}$$

3. Set A TIME/DIV switch to display the portion of the pulse train containing the glitch. Pull the B TIME/DIV knob to unlock it from the A TIME/DIV switch, and set the B TIME/DIV switch to $2 \mu\text{s}$. This will reduce the intensified zone to a small dot (see Figure 31A).

4. Use the DELAY TIME POSITION control to move the intensified zone from trigger point to trigger point. The dot will jump between each trigger point as the delay is changed.

5. When the B Sweep is triggered by the glitch (intensified zone on the glitch), switch the controls as follows:

STORAGE MODE	NORM
STORAGE WINDOW	POST TRIG
DISPLAY RESPONSE	PULSE
HORIZ DISPLAY	B DLY'D

6. Adjust the INTENSITY control as necessary for desired display brightness. The glitch should be seen on the left side about one division in from the start of the trace (see Figure 31B). It may be expanded further by setting the B TIME/DIV switch to the faster sweep speeds (see Figure 31C).

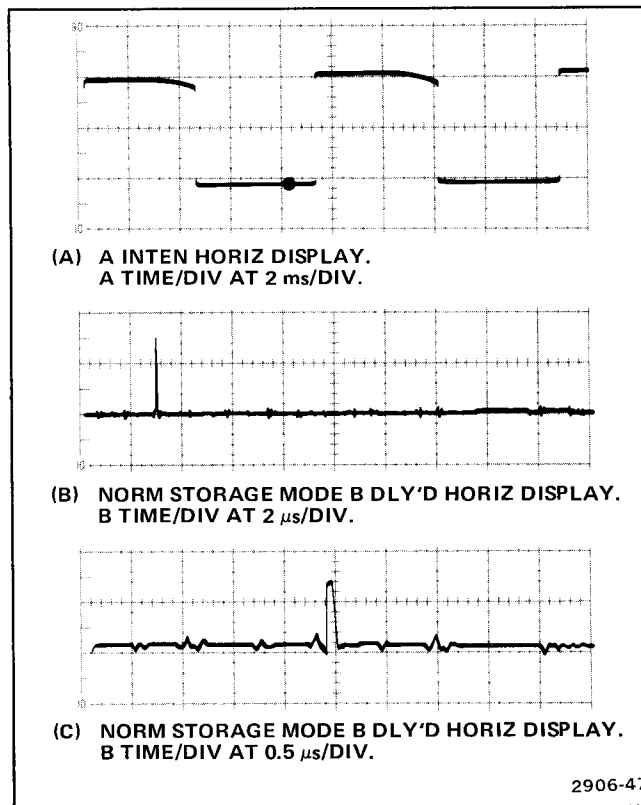

Figure 31. Glitch display, NORM Storage Mode using B DLY'D HORIZ DISPLAY.

DELAYED SWEEP TIME MEASUREMENTS

Operating the 468 Oscilloscope with the HORIZ DISPLAY set to either ALT or A INTEN will permit time measurements to be made with a greater degree of accuracy than attained with HORIZ DISPLAY set to A. The following procedures describe how these measurements are accomplished.

Time Duration

1. Obtain a Normal Sweep Display. Use a VOLTS/DIV setting to obtain a display about 5 divisions in vertical amplitude. Ensure that the TIME/DIV VAR control is in the calibrated detent and set the A TIME/DIV switch to obtain a display of the entire time duration to be measured.

2. Press in the A INTEN HORIZ DISPLAY push button.

3. For the most accurate measurements, set the B TIME/DIV switch to the fastest sweep rate that provides a usable (visible) intensified zone. Vertically position the A trace to place the time-measurement point on the waveform at the center horizontal graticule line (see Figure 43).

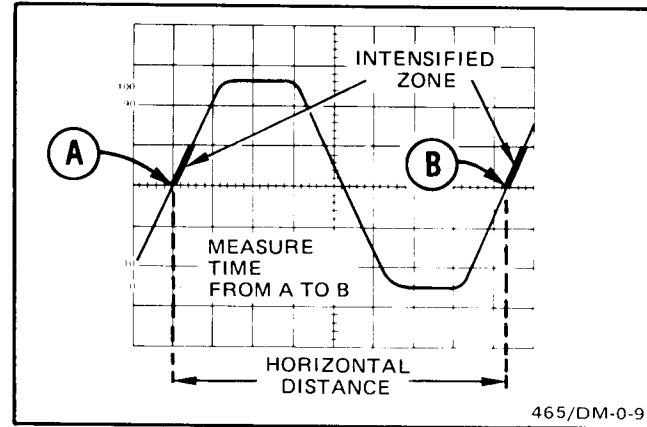

Figure 43. Time duration using delayed sweep.

4. Ensure that the B Trigger SOURCE switch is set to STARTS AFTER DELAY. Use the DELAY TIME POSITION control to move the start of the intensified zone so that it just touches the intersection of the signal and the center horizontal graticule line (see Figure 43, point A).

5. Record the DELAY TIME POSITION control dial setting.

7. Press the SAVE Storage Mode button to hold the acquired waveform and provide a more stable display for measurement. The SAVE Storage Mode display may be horizontally expanded up to 100 times using the TIME/DIV switch (if enough TIME/DIV positions remain) and vertically expanded up to 10 times, using the VOLTS/DIV switch associated with the channel from which the signal was acquired.

NOTE

At sweep speeds of $2\ \mu\text{s}/\text{div}$ and faster, one sample per 40 ns is made, and a 50-ns pulse will have only one or two samples (depending upon the trigger jitter) from which to reconstruct the pulse for display. The exact pulse shape will not be displayed and pulse width measurements will be approximate (within one sample period). Amplitude measurements made on waveforms acquired in NORM Storage Mode will be valid on pulses as narrow as approximately 40 ns wide.

Missing Pulse

ENVELOPE Storage Mode is useful for finding an intermittent pulse in a pulse train. The pulse may either be missing or present erratically. In either case, the change in

amplitude levels will be displayed as a completely filled in pulse (see Figure 32).

1. Acquire a NORM Storage Mode display. Select triggers, TIME/DIV setting, and storage window (PRE TRIG or POST TRIG) to obtain the pulse train of interest.

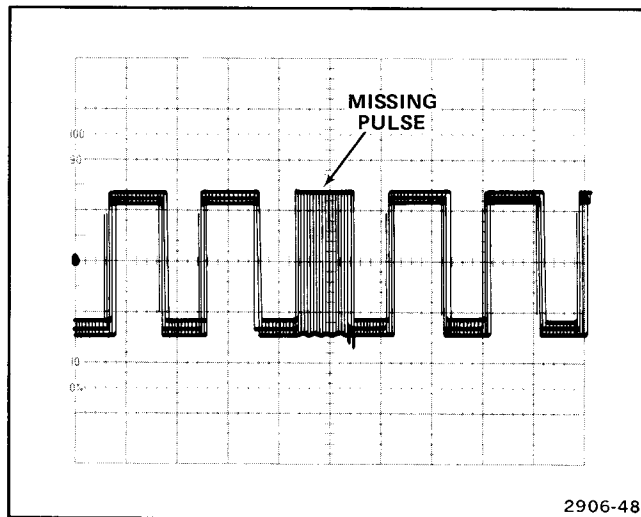

Figure 32. Missing pulse, ENVELOPE Storage Mode.

Triggered Delayed Sweep Magnification

The delayed sweep magnification method described in the preceding paragraph may produce excessive jitter at high apparent magnification ranges. Operating the B Sweep in a triggered mode provides a more stable display, because the delayed display will be triggered at the same trigger level each time.

1. Perform steps 1 through 6 of the preceding "Magnified Sweep Starts After Delay" procedure.

2. Set the B Trigger SOURCE switch to the same position as the A Trigger SOURCE switch. If external triggering is used, it will be necessary to connect the required signal to the B External Trigger input connector.

3. Adjust the B Trigger LEVEL control so the intensified zone on the A trace is stable. (If an intensified zone cannot be obtained, see step 4.)

4. Inability to intensify the desired portion indicates that the signal does not meet the triggering requirements. If the condition cannot be remedied either by using the B Sweep

NOTE

The DELAY TIME POSITION control will not provide continuously variable delay when the B Trigger SOURCE switch is set to any position other than STARTS AFTER DELAY. Adjustment of the DELAY TIME POSITION control will still position the B Sweep in respect to the A Sweep, but the B Sweep will occur only when properly triggered. The intensified zone seen in both the ALT and A INTEN Horizontal Displays will move from trigger point to trigger point as the DELAY TIME POSITION control is adjusted.

Differential time measurements are not valid unless the B Trigger SOURCE switch is set to STARTS AFTER DELAY.

triggering controls or by increasing the display amplitude, you should: lower the VOLTS/DIV switch setting, set the B Trigger SOURCE switch to EXT to trigger the B Sweep externally, and then set the VOLTS/DIV switch for the desired display amplitude.

5. Measurements are made, and magnification factors are calculated in the same manner as described previously in the "Magnified Sweep Starts After Delay" procedure.

2. Press the ENVELOPE Storage Mode button in to acquire an envelope display. Press the NO. OF SWEEPS button in and use the CURSOR/NO. OF SWEEPS control knob to set the number of sweeps to be acquired to unlimited (9999). Press the NO. OF SWEEPS button again to release it and return the readout to cursor control.

If the waveform acquired is repetitive, each pulse in it will show only the envelope of the pulse. A pulse missing or present part of the time will show a completely filled display at the pulse location. Pulse breakdown (erratic changes in amplitude or width) will also be displayed by the ENVELOPE Storage Mode.

6. Use the DELAY TIME POSITION control to position the start of the intensified zone to that portion of the A trace that is to be magnified.

7. Set the B TIME/DIV switch to a setting which intensifies the full portion of the A trace to be magnified. The intensified zone will be displayed as the B trace (see Figure 42). Set the INTENSITY and B INTENSITY controls as required to display the B trace (magnified portion of the A trace).

8. Time measurements can be made from the B trace display in the conventional manner. The sweep rate is determined by the setting of the B TIME/DIV switch. The B DLY'D HORIZ DISPLAY may also be used for making time measurements.

9. The apparent sweep magnification can be calculated from the following formula:

$$\text{Apparent Delayed Sweep Magnification} = \frac{\text{A TIME/DIV switch setting}}{\text{B TIME/DIV switch setting}}$$

EXAMPLE: Determine the apparent magnification of a display with an A TIME/DIV switch setting of 0.1 ms and a B TIME/DIV switch setting of 1 μ s.

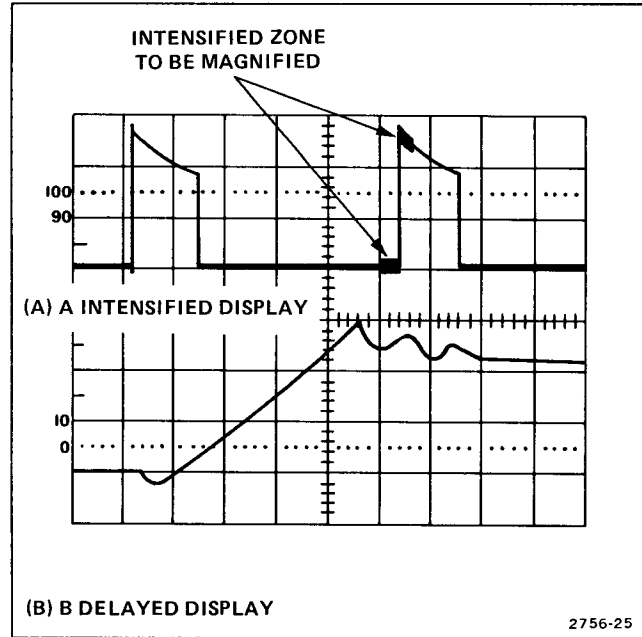

Figure 42. Delayed sweep magnification.

Substituting the given values:

$$\text{Apparent Magnification} = \frac{1 \times 10^{-4} \text{ s}}{1 \times 10^{-6} \text{ s}} = 10^2 = 100$$

MAKING NONSTORAGE MEASUREMENTS

The following procedures will enable the operator to make basic measurements using the conventional oscilloscope capabilities of the 468. Many of these measurements can be obtained with either the nonstorage mode or one of the storage modes. After becoming familiar with all the capabilities of the 468, the operator can then choose the best method for making a particular measurement.

When the procedures first call for obtaining a Normal Sweep Display, refer to the "Oscilloscope Displays" section. The initial control settings listed in the Normal Sweep Display procedure are considered as the initial control setup. Alternate control settings are usually required for making a specific measurement. The operator must determine the correct control settings applicable to VOLTS/DIV, TIME/DIV, Trigger MODE, Trigger LEVEL, and other controls to obtain a stable display of the desired display.

AC PEAK-TO-PEAK VOLTAGE

NOTE

Either channel input connector may be used for the signal input. Use the VERT MODE switch to select the appropriate channel for display.

1. Apply the signal to be measured to the selected channel input and obtain a Normal Sweep Display.
2. Ensure that the VOLTS/DIV VAR control is in the calibrated detent and vertically position the display so that the negative peak of the waveform coincides with one of the horizontal graticule lines (see Figure 33, point A).
3. Horizontally position the display so that one of the positive peaks coincides with the center vertical graticule line (see Figure 33, point B).

displaying a selected portion of the A trace at a faster sweep rate (B DLY'D Sweep rate). The A TIME/DIV switch setting determines how often the B trace will be displayed. Since the B Sweep can occur only once for each A Sweep, the A Sweep time duration sets the amount of time elapse between succeeding B Sweeps.

The B Time/DIV switch setting determines the B Sweep rate, and it sets the length of the intensified zone on the A trace when using either ALT or A INTEN Horizontal Display modes. The intensified zone is an indication of both the location and length of the B Sweep interval with respect to the A Sweep interval. Positioning of the intensified zone (actually, setting the amount of time between the start of the A Sweep and the start of the B Sweep) is accomplished with the use of the DELAY TIME POSITION control.

With the B Trigger SOURCE switch set to STARTS AFTER DELAY, the DELAY TIME POSITION control provides continuously variable positioning of the start of the B Sweep. The range of the control is sufficient to place the B Sweep interval to any location within the A Sweep interval.

Using STARTS AFTER DELAY as the B Trigger SOURCE may produce a display with some slight horizontal movement (pulse jitter). Pulse jitter includes the inherent un-

certainty of triggering the delayed sweep at exactly the same trigger point each time. If jitter becomes excessive in the delayed sweep display, use the "Triggered Delay Sweep Magnification" procedure rather than the "Magnified Sweep Starts After Delay" procedure.

Magnified Sweep Starts After Delay

1. Obtain a Normal Sweep Display.
2. Set the appropriate VOLTS/DIV switch to produce a display of approximately two divisions in amplitude.
3. Set the A TIME/DIV switch to a sweep rate that displays several waveform cycles.
4. Press in the ALT HORIZ DISPLAY push button and set the B Trigger SOURCE switch to STARTS AFTER DELAY.
5. Adjust both the selected channel POSITION control and the TRACE SEP control to display the A trace above the B trace.

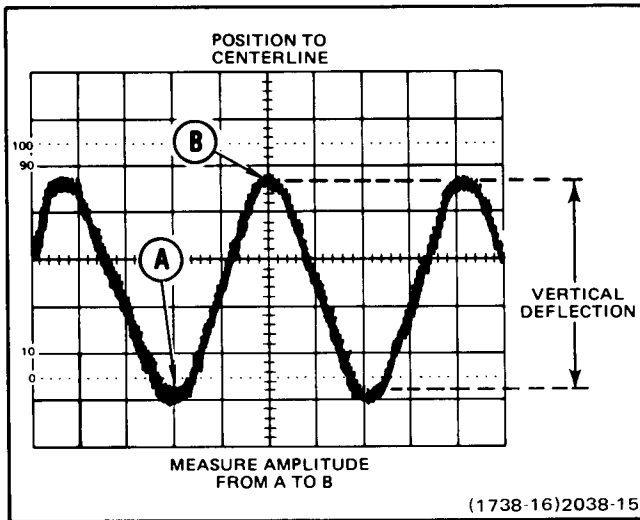

Figure 33. Peak-to-peak waveform measurement.

4. Measure the vertical deflection from peak to peak (see Figure 33, point A to point B).

NOTE

If the amplitude measurement is critical or if the trace is thick (as a result of hum or noise on the signal), a more accurate measurement can be obtained by measuring from the top of a peak to the top of a valley (or bottom of a peak to bottom of a valley). This will eliminate trace thickness from the measurement.

5. Calculate the peak-to-peak voltage, using the following formula:

$$\text{Volts (p-p)} = \frac{\text{Vertical Deflection}}{\text{Factor}} \times \text{VOLTS/DIV switch setting}$$

NOTE

The attenuation factor of the probe being used must be included if it is not a 10X scale-factor-switching probe.

EXAMPLE: The measured peak-to-peak vertical deflection is 4.6 divisions (see Figure 33) with a VOLTS/DIV switch setting of 0.5, using a 10X scale-factor-switching probe.

HIGH-RESOLUTION PHASE DIFFERENCE

More accurate phase measurements can be made by using the X10 MAG function to increase the sweep rate without changing the TIME/DIV VAR control setting (see Figure 41).

EXAMPLE: If the sweep rate were increased 10 times with the magnifier (X10 MAG push button in), the magnified horizontal graticule calibration would be $45^\circ/\text{div}$ divided by 10 (or $4.5^\circ/\text{div}$). Figure 41 shows the same signals illustrated in Figure 40, but magnifying the displays results in a horizontal difference of 5.8 divisions between the two signals. The phase difference is:

$$\text{Phase Difference} = \text{Horizontal difference (divisions)} \times \text{Horizontal graticule calibration (degrees/div)}$$

Substituting the given values:

$$\text{Phase Difference} = 5.8 \text{ divisions} \times 4.5^\circ/\text{div} = 27^\circ$$

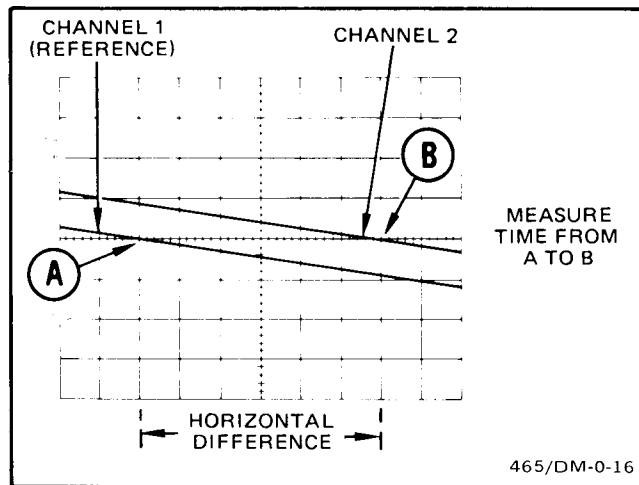

Figure 41. High-resolution phase difference.

DELAYED SWEEP MAGNIFICATION

The delayed sweep feature of the 468 can be used to provide higher apparent magnification than is provided by the X10 MAG function. Magnification occurs as a result of

Substituting the given values:

$$\text{Volts (p-p)} = 4.6 \text{ divisions} \times 0.5 \text{ V/div} = 2.3 \text{ V.}$$

INSTANTANEOUS DC VOLTAGE

NOTE

Either channel input connector may be used for the signal input. Use the VERT MODE switch to select the appropriate channel for display.

1. Apply the signal to be measured to the selected channel input and obtain a Normal Sweep Display.

2. Ensure that the VOLTS/DIV VAR control is in the calibrated detent and determine the polarity of the voltage to be measured as follows:

a. Set the AC-GND-DC switch to GND and vertically position the baseline trace to the center horizontal graticule line.

b. Set the AC-GND-DC switch to DC. If the waveform moves above the center line of the crt, the voltage is

positive. If the waveform moves below the center line of the crt, the voltage is negative.

3. Set the AC-GND-DC switch to GND and position the baseline trace to a convenient reference line. For example, if the voltage to be measured is positive, position the baseline trace to the bottom graticule line. If a negative voltage is to be measured, position the baseline trace to the top graticule line.

4. Set the AC-GND-DC switch to DC. Measure the divisions of vertical deflection between the reference line and the desired point on the waveform (see Figure 34).

5. Calculate instantaneous voltage, using the following formula:

$$\text{Instantaneous Voltage} = \frac{\text{Vertical distance}}{\text{(divisions)}} \times \text{Polarity (+ or -)} \times \text{VOLTS/DIV switch setting}$$

NOTE

The attenuation factor of the probe being used must be included if it is not a 10X scale-factor-switching probe.

5. Set the CH 1 and CH 2 VOLTS/DIV switches and the CH 1 and CH 2 VOLTS/DIV controls to produce displays that are equal in amplitude (about 5 divisions each).

6. Use the Vertical POSITION controls to vertically center both signals around the center horizontal graticule line.

7. Set the TIME/DIV switch to display at least one full cycle of the waveform over the 10 graticule divisions. Position the display and adjust the TIME/DIV VAR control to place one reference signal cycle in exactly 8 divisions at the 50% rise-time points (see Figure 40).

Each division of the graticule now represents 45° of the full cycle ($360^\circ/8 \text{ div}$), and the horizontal graticule calibration can be stated as $45^\circ/\text{division}$.

8. Measure the horizontal difference between corresponding points on the waveforms as a common horizontal graticule line (at 50% of the rise time), and calculate the phase difference using the following formula:

$$\text{Phase Difference} = \text{Horizontal difference (divisions)} \times \text{Horizontal graticule calibration (degrees/div)}$$

EXAMPLE: The horizontal difference is 0.6 division with a graticule calibration of $45^\circ/\text{div}$ as shown in Figure 40.

Substituting the given values into the phase difference formula:

$$\text{Phase Difference} = 0.6 \text{ div} \times 45^\circ/\text{div} = 27^\circ$$

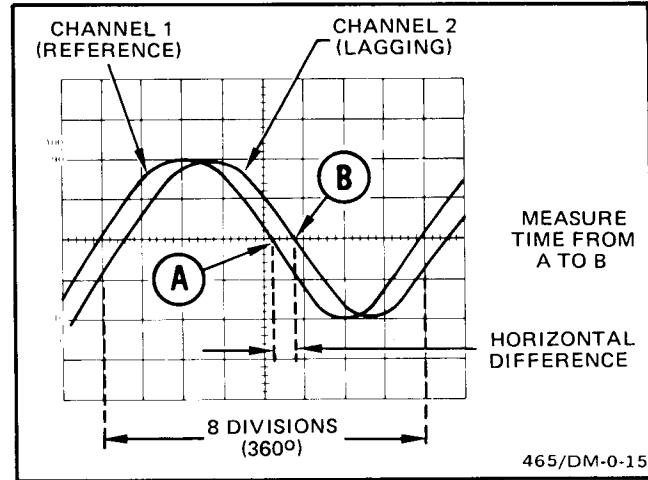

Figure 40. Phase difference.

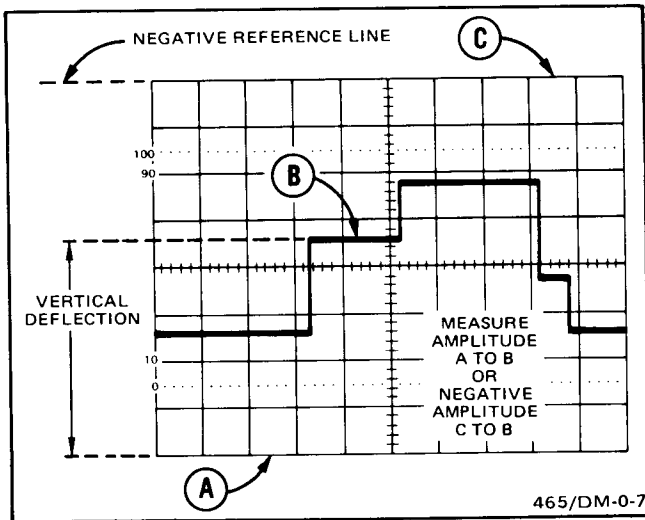

Figure 34. Instantaneous voltage measurement.

EXAMPLE: The vertical distance measured is 4.6 divisions (see Figure 34). The waveform is above the reference line, the VOLTS/DIV switch is set to 2 V, and a 10X scale-factor-switching probe is used.

Substituting the given values into the formula:

$$\text{Instantaneous Voltage} = 4.6 \text{ divisions} \times (+1) \times 2 \text{ V/div} = +9.2 \text{ V.}$$

ALGEBRAIC ADDITION

With the VERT MODE switch in the ADD position, the waveform displayed represents the algebraic sum of the signals applied to the Channel 1 and Channel 2 input connectors (CH 1 + CH 2). If the Channel 2 INVERT switch is pressed in, the resulting waveform is the difference between the signals applied to the Channel 1 and Channel 2 input connectors (CH 1 - CH 2). The total deflection factor in the ADD mode is equal to the deflection factor indicated by either VOLTS/DIV switch (when both VOLTS/DIV switches are set to the same deflection factor). A common use for the ADD mode is to provide a dc offset for a signal riding on top of a high dc level.

The following general precautions should be observed when using the ADD mode:

1. Do not exceed the input voltage rating of the oscilloscope.
2. Do not apply signals that exceed the equivalent of about eight times the VOLTS/DIV switch setting, since large voltages may distort the display. For example, with a VOLTS/DIV switch setting of 0.5 V, the voltage applied to that channel input should not exceed about four volts.

Substituting the given values in the horizontal conversion factor formula:

$$\text{Horizontal Conversion Factor} = \frac{2.19 \text{ ms}}{8 \text{ div} \times 0.2 \text{ ms/div}} = 1.37$$

For the unknown signal, the TIME/DIV switch setting is $50 \mu\text{s}$, and one complete cycle is 7 horizontal divisions in duration. The arbitrary deflection factor is then determined by substituting values in the formula:

$$\text{Arbitrary Deflection Factor} = 1.37 \times 50 \mu\text{s/div} = 68.5 \mu\text{s/div}$$

The time duration of the unknown signal can then be computed by substituting values in the formula:

$$\text{Time Duration} = 68.5 \mu\text{s/div} \times 7 \text{ divisions} = 480 \mu\text{s}$$

The frequency of the unknown signal is then calculated:

$$\text{Frequency} = \frac{1}{480 \mu\text{s}} = 2.083 \text{ kHz}$$

PHASE DIFFERENCE

1. Using probes or coaxial cables with equal time delays, connect a known reference signal to one channel input and connect the unknown signal to the other channel input.

2. Press in both the CH 1 and the CH 2 VERT MODE push buttons. Use either CHOP (in) or ALT (out) VERT MODE switch position, depending on the input signal frequencies. In general, ALT is best for high-frequency signals and CHOP is more suitable for low-frequency signals. The reference signal should precede the comparison signal in time.

3. Use the channel that the reference signal is applied to as the A Trigger SOURCE and obtain a Normal Sweep Display.

NOTE

Inverting the Channel 2 signal subtracts 180° from the phase of the signal. Add 180° to the phase difference obtained to arrive at the correct value if it is necessary to use the INVERT feature.

EXAMPLE: Using the graticule center line as zero volts, the Channel 1 signal is at a three-division, positive dc level (see Figure 35A).

1. Multiply 3 divisions by the VOLTS/DIV switch setting to determine the dc-level.

2. Apply a negative dc level of the value determined in step 1 to the Channel 2 input connector (see Figure 35B). (A

positive dc level may be used if the Channel 2 INVERT switch is used.)

3. Press in the ADD push button to place the resultant display within the operating range of the POSITION controls (see Figure 35C).

4. If you wish to view only the ADD display, release the CH 1 and CH 2 VERT MODE push buttons to remove the Channel 1 and Channel 2 signal displays.

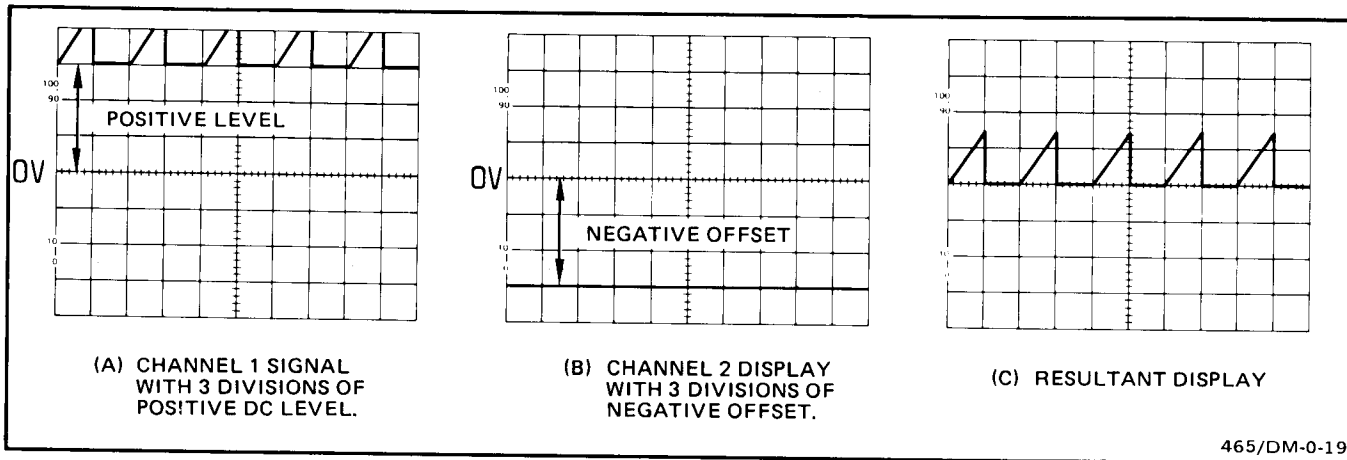

Figure 35. Algebraic addition.

TIME COMPARISON

Repeated time comparisons between unknown signals and a reference signal (e.g., for an assembly-line test) may be easily and accurately made using the 468. To accomplish this, a reference signal of known time duration is first set to an exact number of horizontal divisions by adjusting the TIME/DIV switch and TIME/DIV VAR control. Unknown signals can then be compared with the reference signal without disturbing the setting of the TIME/DIV VAR control. The procedure is as follows:

1. Set the time duration of one full cycle of the reference signal to an exact number of horizontal divisions by adjusting the TIME/DIV switch and TIME/DIV VAR control.

2. Establish a horizontal conversion factor, using the following formula (reference signal time duration must be known):

$$\text{Horizontal Conversion Factor} = \frac{\text{Reference signal time duration (seconds)}}{\text{Horizontal deflection (divisions)} \times \text{TIME/DIV switch setting}}$$

3. For the unknown signal, adjust the TIME/DIV switch to a setting that provides sufficient horizontal deflection to

make an accurate measurement. Do not readjust the TIME/DIV VAR control.

4. Establish an arbitrary deflection factor, using the following formula:

$$\text{Arbitrary Deflection Factor} = \text{Horizontal Conversion Factor} \times \text{TIME/DIV switch setting}$$

5. Measure the horizontal deflection of the unknown signal in divisions and calculate the time duration using the following formula:

$$\text{Time Duration} = \frac{\text{Arbitrary Deflection Factor}}{\text{Horizontal deflection (divisions)}}$$

6. Frequency of the unknown signal can then be determined by calculating the reciprocal of the time duration.

EXAMPLE: The reference signal time duration is 2.19 ms, the A TIME/DIV switch setting is 0.2 ms, and the TIME/DIV VAR control is adjusted to provide a horizontal deflection of exactly 8 divisions.

COMMON-MODE REJECTION

The ADD mode may also be used to display signals that contain undesirable frequency components. These undesirable components can be eliminated using common-mode rejection. The precautions given under the preceding "Algebraic Addition" procedure should be observed.

EXAMPLE: The signal applied to the Channel 1 input connector contains unwanted ac-power-input-source frequency components (see Figure 36A). To remove the undesired components, use the following procedure:

1. Connect an ac-power-input-source frequency signal to the Channel 2 input connector.
2. Set the CHOP-ALT:OUT switch to ALT (out) and press in the Channel 2 INVERT switch. Adjust the Channel 2 VOLTS/DIV and VAR controls so that the Channel 2 display is about the same amplitude as the undesired components of the Channel 1 display (see Figure 36A).
3. Press in the Add push button. Slightly readjust the Channel 2 VOLTS/DIV VAR control for maximum cancellation of the undesired signal component (see Figure 36B).

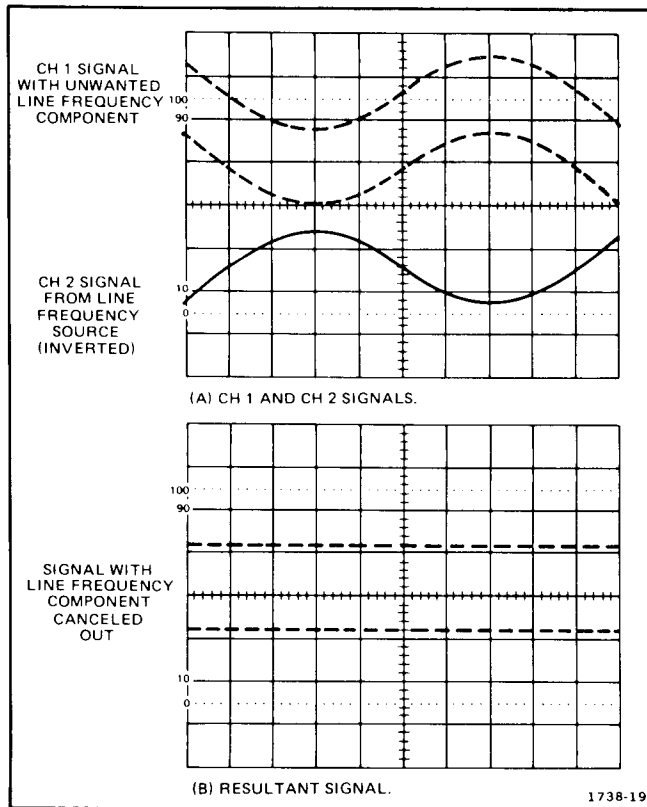

Figure 36. Common-mode rejection.

3. Using either probes or cables with equal time delays, connect the reference signal to the Channel 1 input and the comparison signal to the Channel 2 input.

NOTE

Input signals must be time related for a stable (measurable) display.

4. Press in the CH 1 and CH 2 VERT MODE push buttons. Use either CHOP (in) or ALT (out) VERT MODE switch position, depending on the frequency of the input signals. In general, CHOP is more suitable for low-frequency signals and ALT is best for high-frequency signals. Center each of the displays vertically (see Figure 39).

5. Set the TIME/DIV switch to display at least the two measurement points (one on each trace).

6. Measure the horizontal difference between measurement points on the two signals and calculate the time difference using the following formula:

$$\text{Time Difference} = \frac{\text{TIME/DIV switch setting} \times \text{Horizontal difference (divisions)}}{\text{Magnification Factor}}$$

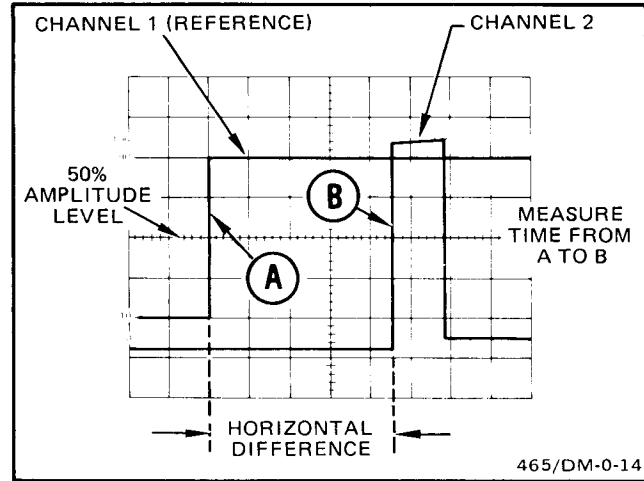

Figure 39. Time difference between two time-related pulses.

EXAMPLE: The TIME/DIV switch is set to 50 μs , the X10 MAG switch is pressed in (on), and the horizontal difference between waveforms is 4.5 divisions.

Substituting the given values in the formula:

$$\text{Time Difference} = \frac{50 \mu\text{s/div} \times 4.5 \text{ div}}{10} = 22.5 \mu\text{s}$$

AMPLITUDE COMPARISON

Repeated amplitude comparisons of unknown signals with a reference signal (e.g., for an assembly line test) may be easily and accurately made using the 468. To accomplish this, a reference signal of known amplitude is first set to an exact number of vertical divisions by adjusting the VOLTS/DIV switch and VAR control. Unknown signals can then be compared with the reference signal without disturbing the setting of the VOLTS/DIV VAR control. The procedure is as follows:

1. Set the amplitude of the reference signal to an exact number of vertical divisions by adjusting the VOLTS/DIV and VAR controls.

2. Establish a vertical conversion factor, using the following formula (reference signal amplitude must be known):

$$\text{Vertical Conversion Factor} = \frac{\text{Reference signal amplitude (volts)}}{\text{Vertical deflection (divisions)} \times \text{VOLTS/DIV switch setting}}$$

3. For the unknown signal, adjust the VOLTS/DIV switch to a setting that provides sufficient vertical deflection

to make an accurate measurement. Do not readjust the VOLTS/DIV VAR control.

4. Establish an arbitrary deflection factor, using the following formula:

$$\text{Arbitrary Deflection Factor} = \text{Vertical Conversion Factor} \times \text{VOLTS/DIV switch setting}$$

5. Measure the vertical deflection of the unknown signal in divisions and calculate the amplitude using the following formula:

$$\text{Unknown Signal Amplitude} = \text{Arbitrary Deflection Factor} \times \text{Vertical deflection (divisions)}$$

EXAMPLE: The reference signal amplitude is 30 V, with a VOLTS/DIV switch setting of 5 V and the VOLTS/DIV VAR control adjusted to provide a vertical deflection of exactly four divisions.

Substituting these values in the Vertical Conversion Factor formula:

$$\text{Vertical Conversion Factor} = \frac{30 \text{ V}}{4 \text{ div} \times 5 \text{ V/div}} = 1.5$$

1. Obtain a Normal Sweep Display of the waveform to be measured. Ensure that the TIME/DIV VAR control is in the calibrated detent.

2. Set the A Trigger SLOPE switch to + (plus). Use a sweep-speed setting that displays several complete cycles or events (if possible).

3. Set the VOLTS/DIV switch and VAR control (or set signal amplitude if desired) for a display of exactly 5 divisions in amplitude.

4. Set vertical positioning so that the zero reference point on the waveform touches the 0% graticule line, and the top of the waveform touches the 100% graticule line.

5. Set the TIME/DIV switch to display the entire leading edge of one cycle of the signal, with the rise time spread horizontally as much as possible within the viewing area.

6. Horizontally position the display so the 10% point on the waveform intersects the second vertical graticule line (see Figure 38).

7. Measure the horizontal distance between the 10% and 90% points and calculate rise time using the following formula:

$$\text{Rise Time} = \frac{\text{Horizontal distance (divisions)} \times \text{TIME/DIV switch setting}}{\text{Magnification Factor}}$$

EXAMPLE: The horizontal distance between the 10% and 90% points is 5 divisions (see Figure 38), and the TIME/DIV switch is set to 1 μs . A magnification factor of 1 is used.

Substituting the given values in the formula:

$$\text{Rise Time} = \frac{5 \text{ div} \times 1 \mu\text{s/div}}{1} = 5 \mu\text{s}$$

TIME DIFFERENCE BETWEEN TWO TIME-RELATED PULSES

1. Obtain a Normal Sweep Display. Ensure that the TIME/DIV VAR control is in the calibrated detent.

2. Set the A TRIGGR SOURCE switch to CH 1.

For the unknown signal, the VOLTS/DIV switch setting is 1 V, and the peak-to-peak amplitude is five vertical divisions. The arbitrary deflection factor is then determined by substituting values in the formula:

$$\begin{aligned} \text{Arbitrary} \\ \text{Deflection} &= 1.5 \times 1 \text{ V/div} = 1.5 \text{ V/div} \\ \text{Factor} \end{aligned}$$

The amplitude of the unknown signal can then be calculated by substituting values in the unknown signal amplitude formula:

$$\text{Amplitude} = 1.5 \text{ V/div} \times 5 \text{ div} = 7.5 \text{ V}$$

TIME DURATION

1. Obtain a Normal Sweep Display of the signal to be measured. Ensure that the TIME/DIV VAR control is in the calibrated detent.

2. Set the TIME/DIV switch for a display of at least one complete period of the waveform to be measured. Position the display to place the time-measurement points on the center horizontal graticule line (see Figure 37).

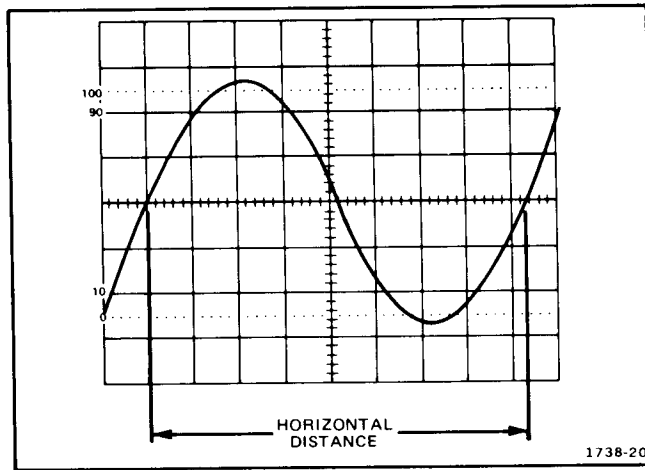

Figure 37. Time duration.

3. Measure the horizontal distance between the time-measurement points.
4. Calculate time duration, using the following formula:

$$\text{Time Duration} = \frac{\text{Horizontal distance (divisions)} \times \text{TIME/DIV switch setting}}{\text{Magnification Factor}}$$

EXAMPLE: The distance between the time-measurement points, illustrated in Figure 37, is 8.3 divisions, and the TIME/DIV switch is set to 2 ms. A magnification factor of 1 is used.

Substituting the given values in the formula:

$$\text{Time Duration} = \frac{8.3 \text{ div} \times 2 \text{ ms/div}}{1} = 16.6 \text{ ms}$$

FREQUENCY

The frequency of a recurrent signal can be determined from its time-duration measurement as follows:

1. Measure the time duration for one period of the waveform using the preceding "Time Duration" measurement procedure.
2. Calculate the reciprocal of the time-duration value to determine the frequency of the waveform.

EXAMPLE: The signal shown in Figure 37 has a time duration of 16.6 ms.

Calculating the reciprocal of time duration:

$$\text{Frequency} = \frac{1}{\text{Time Duration}} = \frac{1}{16.6 \text{ ms}} = 60 \text{ Hz}$$

RISE TIME

The rise time measurement uses the same method as time duration, except that the measurement is made between the 10% and 90% points on the leading edge of the waveform (see Figure 38). Fall time is measured between the 90% and 10% points on the trailing edge of the waveform.

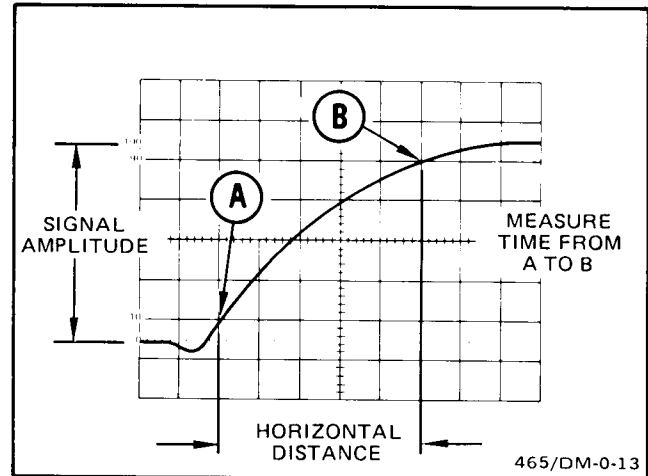

Figure 38. Rise time.